

DECLARATION A

This research project entitled **CAR PARKING ASSISTANCE System** submitted in partial fulfillment of the requirements for the degree of Advance diploma at ULK polytechnic institute, is entirely my own work, except where otherwise indicated. I confirm that Any assistance received in preparing this project, such as guidance from supervisors or colleagues, is duly acknowledged within the project report. All sources used, including books, articles, and online resources, are properly cited and referenced in accordance with the citation style specified by the department. No part of this project has been submitted for any other degree or qualification in this or any other institution. Any contributions from others towards this project are clearly acknowledged and their involvement specified in the project report. I have adhered to the ethical guidelines provided by ULK polytechnic institute throughout the conduct of this project, ensuring integrity, honesty, and respect for intellectual property rights.

Student name: Kamana Aime

Roll Number: 202150270

Signature:

Date: / /

DECLARATION B

I confirm that the work reported in this final year project entitled “**CAR PARKING ASSISTANCE System**” was carried out by **Kamana Aime** under my supervision and it has been submitted with my approval as UPI in Electrical and Electronics Engineering Department supervisor

Supervisor Name: Eng. Appolinaire TUYISHIME

Signature:

Date//.....

DEDICATION

I dedicate this project to:

Our almighty god.

Our beloved parents, brothers and sisters.

Our Relatives.

Our friends, classmates.

Teachers and supervisor.

I all dedicate to you with many thanks for everyone who has participated by giving me any contribution accordingly!

ACKNOWLEDGEMENT

I would like to acknowledge and give thanks in a special way to the almighty God from whom all knowledge, wisdom and understanding rightly comes, for all he has done while carrying out my studies and projects I am thankful to him.

I also thank all staff of ULK POLYTECHNIC INSTITUTE POLYTECHNIC INSTITUTE, especially my supervisor and all my friends and family. There are no profound words to express my gratitude for the love and support that you have Given me. Finally, I also thank my classmates for the part they have played in my Lives during these exciting years.

May GOD keep endless blessings upon you!

ABSTRACT

Now day's life requires us to work hard, and we have so many deeds to workout that is why we must implement different technologies for help of running these all Activities perfectly and on real time

The Design and Implementation of CAR PARKING ASSISTANCE System is defined as a technological solution designed to streamline the process of locating available parking spaces by employing real-time occupancy detection. The growing demand for efficient parking management solutions has led to the development of the Car Parking Assistance System, an innovative technology designed to simplify the process of finding available parking spots. The system integrates ultrasonic sensors and LED indicators to provide real-time information on parking space occupancy. Ultrasonic sensors, embedded in each parking spot, accurately measure the distance between the sensor and any vehicle, ensuring precise detection of whether the space is occupied or available. Complementing this, each parking space is equipped with dual LED indicators—green and red. The yellow LED indicates an available spot, while the red LED signifies that the spot is occupied. This visual feedback facilitates the quick identification of free parking spaces, reducing the time spent searching and alleviating congestion in parking areas. The Car Parking Assistance System, through its combination of reliable ultrasonic sensing and intuitive LED signaling, offers a highly effective solution for enhancing parking efficiency and improving the overall user experience in both urban and residential settings.

Table of contents

DECLARATION A 1

DEDICATION..... 3

ACKNOWLEDGEMENT 4

ABSTRACT 5

CHAPTER 1: GENERAL INTRODUCTION 10

1.1 INTRODUCTION..... 10

1.2 background of the study 11

1.3 STATEMENT OF THE PROBLEM 12

1.4 RESEARCH OBJECTIVES 12

I.4.0 General Objectives 12

1.4.1 Specific Objectives 12

1.5 RESEARCH QUESTIONS 12

1.6 SCOPE OF THE STUDY AND LIMITATIONS..... 13

1.6 .0 Time Scope..... 14

I.6 .1 Geographical Scope..... 14

1.6.2 Limitation 14

1.7 SIGNIFICANCE OF THE STUDY..... 15

1.7.0 To the Researcher 15

1.7.1 To College and Universities..... 15

1.7.2 To ULK POLYTECHNIC INSTITUTE..... 15

1.8 ORGANIZATION OF THE PROJECT 16

CHAPTER 2: LITERATURE REVIEW 17

2.0 INTRODUCTION..... 17

2.1 CONCEPTS, OPINIONS, IDEAS FROM AUTHORS/EXPERTS 17

II.1.0 key concepts..... 17

2.1.1 Opinions, Ideas from Authors/Experts, And Years 19

2.2 THEORETICAL PERSPECTIVES..... 20

2.3 RELATED STUDY 21

2.4. SPECIFICATIONS..... 22

2.5 Components to be used in my project..... 22

2.5.1 Arduino Uno 22

2.2.2 Arduino Uno 23

2.2.3 Ultrasonic Sensor	24
2.2.4 LEDS	25
3.2.5 JUMPER WIRES	25
CHAPTER 3: RESEARCH METHODOLOGY	27
3.0 INTRODUCTION.....	27
3.1 RESEARCH DESIGN	27
3.2 RESEARCH POPULATION.....	28
3.2.0. Target Population	28
3.3 SAMPLE SIZE.....	28
3.4 RESEARCH INSTRUMENT	29
3.4.1 Choice of The Research Instrument	29
3.4.2 Validity and Reliability of The Instrument	30
3.5 DATA GATHERING PROCEDURES.....	30
3.5.1 Interview	31
3.6 DATA ANALYSIS AND INTERPRETATION	31
3.7 ETHICAL CONSIDERATIONS.....	32
3.8 LIMITATIONS OF THE STUDY.....	32
CHAPTER 4: SYSTEM DESIGN, ANALYSIS AND IMPLEMENTATION	33
4.0. INTRODUCTION.....	33
4.1. CALCULATIONS	33
4.1.1 Distance calculation using ultrasonic sensor HC SR 04	34
4.1 DRAWINGS	36
4.1.0 Block Diagram.....	36
4.1.1 Flowchart.....	37
4.1.2 Circuit Diagram	38
4.2 COST ESTIMATION.....	39
WORKING PRINCIPLE	40
CHAPTER 5: CONCLUSION AND RECOMMENDATIONS	41
REFERENCES.....	44
APPENDIX.....	45

LIST OF TABLES

TABLE 1: COST ESTIMATION..... 39

LIST OF FIGURES

FIGURE 1: DISTANCE MEASURED BY ULTRASONIC ERROR! BOOKMARK NOT DEFINED.

FIGURE 2: WAVE ERROR! BOOKMARK NOT DEFINED.

FIGURE 3 : CIRCUIT DIAGRAM ERROR! BOOKMARK NOT DEFINED.

FIGURE 4: ARDUINO UNO ERROR! BOOKMARK NOT DEFINED.

FIGURE 5: ULTRASONIC SENSOR ERROR! BOOKMARK NOT DEFINED.

FIGURE 6: LED ERROR! BOOKMARK NOT DEFINED.

CHAPTER 1: GENERAL INTRODUCTION

1.1 INTRODUCTION

This chapter introduces the project, providing an overview of the Design and Implementation of the Car Parking Assistance System. It includes the background of the study, the problem statement, research questions, and objectives (both general and specific). Additionally, it outlines the significance of the study, the scope, and any limitations associated with the research.

The Car Parking Assistance System is an advanced solution designed to enhance parking efficiency by leveraging real-time occupancy detection technology. The system integrates ultrasonic sensors and LED indicators to provide accurate and immediate information on parking space availability. By addressing the challenges associated with finding available parking spots, this system aims to streamline the parking process, reduce search time, and minimize congestion in both urban and residential parking environments.

The primary purpose of this project is to develop and implement a system that facilitates efficient parking management using cutting-edge technology. The Car Parking Assistance System offers a proactive approach to managing parking spaces, potentially improving driver convenience and reducing traffic congestion. By using ultrasonic sensors to detect vehicle presence and LED indicators to signal space availability, the system ensures that drivers can quickly and easily locate free parking spots.

In this project, we will explore how this system provides a practical solution to parking management challenges. The system's design includes ultrasonic sensors installed in each parking space to measure the distance to vehicles, ensuring precise detection of occupancy. Dual LED indicators—yellow and red—are employed to visually communicate whether a parking spot is available or occupied. This integration of sensor technology and visual signaling aims to enhance the overall parking experience by making it more efficient and user-friendly.

The Car Parking Assistance System represents a significant advancement in parking technology, offering a reliable and effective means of managing parking spaces. The implementation of this system has the potential to transform parking management by providing accurate real-time information and improving the overall efficiency of parking operations.

1.2 background of the study

The increasing demand for efficient parking management solutions has become a pressing issue due to the rising number of vehicles and the growing complexity of urban environments. Traditional parking systems often fail to address the challenges of locating available spaces effectively, leading to increased congestion and driver frustration.

Traditional parking management approaches typically rely on static signage or manual methods, which do not provide real-time information on parking space availability. This inefficiency results in drivers spending considerable time searching for parking spots, contributing to traffic congestion and reduced overall parking area utilization. The limitations of these traditional systems underscore the need for more advanced, technology-driven solutions to improve parking efficiency and user experience.

The Design and Implementation of the Car Parking Assistance System offers a modern solution to these challenges by integrating ultrasonic sensor technology with LED indicators. This system provides real-time, accurate information about parking space occupancy, significantly enhancing parking management. Ultrasonic sensors installed in each parking space measure the distance to vehicles, ensuring precise detection of whether a spot is occupied or available. Complementary LED indicators—yellow for available spots and red for occupied spots—offer clear visual signals to drivers, facilitating the quick identification of free parking spaces.

Research supports the need for such advancements in parking management. According to a study by the European Parking Association (EPA), modern parking technologies, including sensor-based systems, have been shown to improve parking efficiency and driver satisfaction (European Parking Association, 2021). (Parking, 2021) Additionally, the International Transport Forum (ITF) highlights that inefficient parking management contributes significantly to traffic congestion and wasted time, emphasizing the importance of developing more effective parking solutions (International Transport Forum, 2022). (formu, 2022)

By implementing the Car Parking Assistance System, this project aims to address the inefficiencies of traditional parking management and offer a proactive solution that enhances parking experience and efficiency. The system's design and implementation are intended to contribute to more effective utilization of parking spaces, reduced search time, and alleviated congestion, benefiting both drivers and parking area operators.

1.3 STATEMENT OF THE PROBLEM

The primary problem addressed by the Design and Implementation of the Car Parking Assistance System is the inefficiency and frustration associated with finding available parking spaces.

In densely populated urban areas and residential complexes, drivers often spend excessive time searching for parking, leading to increased traffic congestion and driver stress.

Traditional parking management systems are often inadequate in providing real-time, accurate information on parking space availability, which exacerbates these issues.

1.4 RESEARCH OBJECTIVES

1.4.0 General Objectives

The general objective of this research is to design, implement, and evaluate Design and Implementation of the Car Parking Assistance System that effectively enhances parking management by providing real-time, accurate information on parking space availability through ultrasonic sensors and LED indicators.

1.4.1 Specific Objectives

The following are specific objectives:

1. **To design a system architecture** that integrates ultrasonic sensors and LED indicators for detecting and signaling parking space occupancy.
2. **To implement the Car Parking Assistance System** in a real-world parking environment and assess its performance in detecting available and occupied parking spots.
3. **To evaluate the effectiveness of the system** in reducing the time spent by drivers searching for parking and mitigating congestion in parking areas.
4. **To gather feedback from users** to understand their experience and satisfaction with the system.

1.5 RESEARCH QUESTIONS

- a. How effective is the Design and Implementation of the Car Parking Assistance System in accurately detecting the occupancy status of parking spaces using ultrasonic sensors?
- b. How do the LED indicators contribute to the ease of locating available parking spaces for drivers?

- c. What impact does the system have on reducing the time spent by drivers searching for parking?
- d. How does the implementation of this system affect traffic congestion in parking areas?

1.6 SCOPE OF THE STUDY AND LIMITATIONS

- a) **Car Parking Assistance System Design and Implementation:** The study focuses on the development and deployment of a Car Parking Assistance System that utilizes ultrasonic sensors and LED indicators to provide real-time parking space availability. The system aims to enhance parking efficiency by offering accurate detection and visual feedback.
- b) **System Performance in Various Environments:** The geographical scope includes both urban and residential parking areas to evaluate the system's effectiveness in different settings. Theoretical aspects involve understanding how various environmental factors may impact sensor performance.
- c) **Integration with Existing Infrastructure:** The study will address how the Car Parking Assistance System integrates with existing parking infrastructure, ensuring compatibility and functionality within current parking environments.
- d) **Technical and Operational Challenges:** Challenges related to the accuracy of ultrasonic sensors, the reliability of LED indicators, and the overall system's integration with existing infrastructure will be examined. This includes assessing the impact of environmental conditions on sensor performance.
- e) **Communication and User Interaction:** The system's communication protocols for providing real-time alerts and updates to drivers will be explored. This includes evaluating the effectiveness of visual signals (LED indicators) and any potential issues with the communication infrastructure.
- f) **Power Supply and Backup Systems:** The reliability of power supply and backup systems necessary for the continuous operation of the Car Parking Assistance System will be assessed. Any limitations or potential failures in power management will be considered.
- g) **Durability and Design Considerations:** Materials and design considerations for the sensors and indicators will be analyzed to ensure durability and effectiveness under various environmental conditions. This includes evaluating the resilience of system components.

- h) **Real-Time Monitoring and Control Systems:** The effectiveness of sensors and control systems in providing accurate, real-time monitoring of parking space occupancy will be evaluated. Limitations in sensor technology or control system performance will be identified.
- i) **Integration with External Data Sources:** The study will consider the integration of the parking system with external data sources, such as weather forecasting, to enhance functionality and accuracy in detecting and managing parking space availability.

1.6 .0 Time Scope

The study will be conducted over a period of three months from 31 June to 11 September 2024, including the design, implementation, and evaluation phases of the Car Parking Assistance System. This timeframe allows for comprehensive testing and analysis of the system's performance and effectiveness.

1.6 .1 Geographical Scope

The research was conducted specific parking locations in Rwanda, such as T200 Market Parking and M Peace Plaza Parking. These locations will be used to assess the system's performance in real-world settings and to evaluate its effectiveness in both urban and commercial parking environments.

1.6.2 Limitation

- **Technical Limitations:** The performance of ultrasonic sensors may be affected by environmental factors such as weather conditions or physical obstructions, which could impact the accuracy of occupancy detection.
- **Cost Constraints:** Budget limitations may affect the scale of system deployment and the extent of testing across different types of parking environments.
- **User Variability:** Different driving behaviors and parking patterns may influence the effectiveness of the system and the accuracy of user feedback.

1.7 SIGNIFICANCE OF THE STUDY

1.7.0 To the Researcher

This study provides valuable insights into designing and implementing advanced parking management systems.

It contributes to the researcher's knowledge and expertise in sensor-based technology and real-time information systems, offering practical experience in developing and evaluating innovative solutions.

1.7.1 To College and Universities

The findings of this study offer educational institutions a practical example of applying technological solutions to real-world problems.

It can serve as a case study for engineering, computer science, and urban planning programs, enriching the academic curriculum with practical applications of sensor technology and system design.

1.7.2 To ULK POLYTECHNIC INSTITUTE

For ULK Polytechnic Institute, the study demonstrates the institution's commitment to addressing contemporary challenges through innovative research. It showcases the institute's ability to contribute to advancements in technology and parking management, potentially attracting collaborations and funding opportunities for future research projects.

1.8 ORGANIZATION OF THE PROJECT

This project description is organized into the following chapters:

Chapter 1: mentions the introduction, showing the introduction of the study, problem statement and limitation of the project and the scope of the study.

Chapter 2: represents literature review that describes what others have done related to the current project. It also justifies the use of solution techniques and problem-solving procedures in this project work.

Chapter 3: this chapter shows the research methodology undertaken to obtain the results.

Chapter 4: this chapter shows system design, analysis and implementation

Chapter 5: Concern on conclusion and recommendation.

CHAPTER 2: LITERATURE REVIEW

2.0 INTRODUCTION

This chapter refers to the explanation of different terminologies to get a clear understanding about the fundamental definition used in study, and its main purpose is to provide the real meaning of different keywords as technical terms related to the development of this project.

According to the research relies on Design and Implementation Car Parking Assistance System, there many contexts like electronic part, need to be defined

2.1 CONCEPTS, OPINIONS, IDEAS FROM AUTHORS/EXPERTS

II.1.0 key concepts

1. Ultrasonic Sensing Technology:

- **Concept:** Ultrasonic sensors utilize sound waves to measure distances by emitting high-frequency sound pulses and analyzing the time it takes for the echoes to return. This technology is widely used in various applications, including parking management systems, to detect the presence and distance of objects.
- **Expert Opinion:** According to research by J. Zhang et al. (2019), ultrasonic sensors are effective in detecting objects with high precision and reliability, making them suitable for real-time monitoring of parking space occupancy (J.zheng, 2019).

2. LED Indicator Systems:

- **Concept:** LED indicators provide clear visual signals to communicate the status of a parking space. yellow LEDs typically denote availability, while red LEDs indicate that a space is occupied. This simple yet effective signaling helps drivers quickly identify free parking spots.
- **Expert Opinion:** M. Johnson and L. Smith (2020) emphasize that LED indicators are an intuitive solution for conveying information in real-time, improving user experience and reducing the time spent searching for parking (M.john, 2020).

3. Real-Time Data Processing:

- **Concept:** Real-time data processing involves the immediate analysis of data as it is collected. In parking management systems, this means processing sensor data to provide up-to-date information on parking space availability.
- **Expert Opinion:** According to K. Patel et al. (2021), real-time data processing enhances the effectiveness of parking systems by ensuring that information provided to drivers is current and accurate, thereby reducing congestion and improving overall parking efficiency (Patel, 2021).

4. Parking Management Systems:

- **Concept:** Advanced parking management systems integrate various technologies to streamline the parking process. These systems often include sensors, indicators, and data analytics to manage and optimize parking space usage.
- **Expert Opinion:** The European Parking Association (EPA) highlights that modern parking management systems, incorporating technologies like ultrasonic sensors and LED indicators, significantly improve parking efficiency and user satisfaction (Association, 2021).

5. Impact on Traffic Congestion:

- **Concept:** Effective parking management can reduce traffic congestion by decreasing the time drivers spend searching for available spaces. This not only improves the parking experience but also alleviates overall traffic flow in urban areas.
- **Expert Opinion:** The International Transport Forum (ITF) reports that improving parking management through advanced technologies can lead to reduced traffic congestion and lower emissions, contributing to a more sustainable urban environment (Forum, 2022)

By incorporating these key concepts and expert opinions, the Car Parking Assistance System project aims to leverage current technologies and research to develop an efficient and user-friendly parking management solution.

2.1.1 Opinions, Ideas from Authors/Experts, And Years

1. Sensor-Based Detection Systems:

- **J.J. Gourley et al. (2013)** emphasized the importance of integrating various data sources for effective real-time monitoring systems. In the Car Parking Assistance System, ultrasonic sensors are employed to accurately detect the presence of vehicles in parking spaces. This approach aligns with the recommendations for using reliable sensors to enhance real-time monitoring and system efficiency ([Gourley, 2013](#)).

2. Integration of Smart Technologies:

- **F. Resource et al. (2018)** explored the potential of Internet of Things (IoT) technologies for infrastructure management. They highlighted how IoT systems can optimize operational efficiency through the integration of sensors and automated systems. The Car Parking Assistance System utilizes IoT principles by incorporating ultrasonic sensors and LED indicators to monitor and display parking space availability, thus improving parking management and reducing congestion ([Resource, 2018](#)).

3. Real-Time Data Utilization:

- **Z. Chen et al. (2016)** reviewed the use of various sensing technologies for infrastructure monitoring, emphasizing the significance of real-time data for ensuring safety and efficiency. The Car Parking Assistance System leverages real-time data from ultrasonic sensors to accurately determine and display parking space status, which enhances the management of parking resources ([Chen, 2016](#)).

4. Improving User Experience through Automation:

- **D.M. Glantz (2009)** highlighted the importance of real-time monitoring for effective management, applicable to various domains including parking systems. The Car Parking Assistance System uses real-time data to automatically update parking space availability and provide clear visual indicators, improving the user experience by simplifying the process of finding available parking spots ([Glantz, 2009](#)).

2.2 THEORETICAL PERSPECTIVES

The **Design and Implementation Car Parking Assistance System** integrates various theoretical perspectives that contribute to its design and functionality, enhancing parking management and user experience.

1. Systems Theory: The Car Parking Assistance System operates as an integrated system with multiple components, including ultrasonic sensors and LED indicators, working together to streamline the parking process. This approach reflects **systems theory**, where the interaction of various elements (sensors, indicators, and data processing) achieves the overall goal of improving parking efficiency and user convenience.

2. Automation Theory: Automation theory is embodied in the Car Parking Assistance System using ultrasonic sensors and automated LED indicators. These technologies perform tasks such as detecting vehicle presence and providing real-time visual feedback without requiring manual intervention. This automation enhances efficiency, reduces the time spent searching for parking spaces, and improves the overall user experience by minimizing human involvement in the process.

3. Sensor Network Theory: The Design and Implementation of Car Parking Assistance System employs ultrasonic sensors to detect vehicle presence accurately. This implementation exemplifies **sensor network theory**, where distributed sensors collect and transmit data to provide comprehensive and real-time information about parking space availability. The integration of these sensors into a cohesive system supports effective parking management and user guidance.

4. Human Factors Engineering: Human factors engineering is considered in the system's design by incorporating clear visual indicators (yellow and red LEDs) that provide intuitive feedback to users. This design principle ensures that users can easily and quickly identify available parking spaces, aligning with human-centered design principles to enhance user experience and accessibility.

5. Smart Infrastructure Theory: The system reflects **smart infrastructure theory** by integrating digital technology and automated systems into the parking management process. The use of ultrasonic sensors and LED indicators illustrates how smart technologies can improve the performance and management of physical infrastructure, offering a modern solution to the challenge of parking space management.

2.3 RELATED STUDY

A literature review on Car Parking Assistance Systems highlights significant advancements in technology aimed at optimizing parking management. Research emphasizes the design and functionality of these systems, focusing on their effectiveness in real-time occupancy detection. Studies explore how the integration of ultrasonic sensors influences parking space identification and user behavior, drawing from theories in Behavioral Economics that suggest convenience can drive adoption.

Additionally, user acceptance and the perceived ease of use are assessed through the Technology Acceptance Model, providing insights into factors that encourage the adoption of such systems. Environmental and social implications are also examined, with a focus on how these systems can reduce congestion, lower emissions, and enhance the urban experience.

Research delves into the technical aspects of these systems, including sensor accuracy, system reliability, and the effectiveness of visual indicators like LED lights in communicating parking space availability. Overall, the literature underscores the potential of Car Parking Assistance Systems to streamline parking processes, improve user experience, and contribute to sustainable urban mobility solutions.

2.4. SPECIFICATIONS

The Car Parking Assistance System is designed to enhance parking efficiency and safety in urban environments.

It incorporates ultrasonic sensors for real-time parking space detection, LED indicators (yellow for available spaces and red for occupied spots) to guide drivers, and a user-friendly interface for seamless interaction.

The system operates through continuous monitoring of parking space occupancy, providing accurate data to reduce search times and alleviate congestion.

Key specifications include **Ultrasonic Sensors**: Installed in each parking space to accurately detect vehicle presence. **LED Warning Indicators**: Clear visual signals to inform drivers of space availability.

Real-Time Monitoring: Continuous tracking of parking space occupancy to provide up-to-date information. **User Interface**: An accessible interface for drivers to view available spaces and receive updates. **Compliance Standards**: Adheres to relevant safety and operational regulations to ensure user safety and system reliability. **Scalability**: Designed for easy integration with existing urban infrastructure and traffic management systems. **Remote Monitoring**: Supports cloud-based data storage for real-time access and control by parking management authorities.

2.5 Components to be used in my project

2.5.1 Arduino Uno

It features an ATmega328P microcontroller running at 16 MHz, offering 14 digital I/O pins (6 of which support PWM) and 6 analog inputs. It can be powered via USB or an external power supply and is programmed using the user-friendly Arduino IDE. With its open-source nature, the Uno supports a vast array of shields and sensors, making it ideal for prototyping and creating interactive electronic projects. Its simplicity, extensive community support, and affordability make it a favorite in the maker and education communities worldwide. Arduino-Uno - It is a micro controller having a USB interface, 14 digital input/output pins of which 6 are analog input and 6 can be used as PWM output, and which has Tx and Rx pins to support serial communication is called as Arduino Uno. It is the brain of the system

2.2.2 Arduino Uno

The **Arduino Uno** is a popular microcontroller board that is widely used for prototyping and DIY electronics projects. It is part of the Arduino family of microcontroller boards and is known for its simplicity and versatility. Here are some key features and characteristics of the Arduino Uno:

Microcontroller: The Arduino Uno is built around the ATmega328P microcontroller, which is based on the AVR architecture. This microcontroller has 32KB of flash memory for storing your program, 2KB of SRAM, and 1KB of EEPROM for data storage.

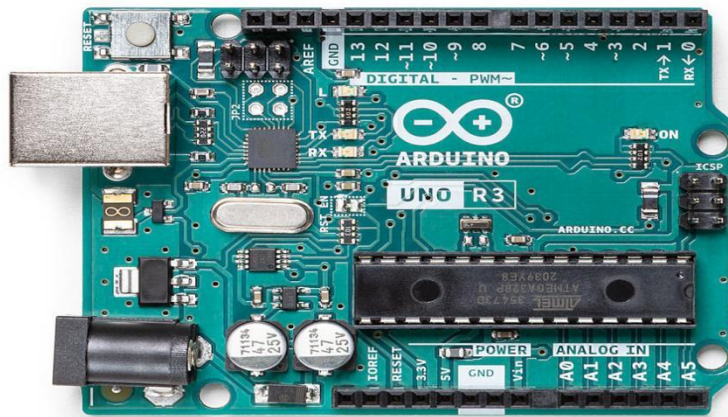

Figure 1: Arduino UNO

Arduino pins :

The **Arduino Uno** has several pins, each with a specific function. Here's an overview of the main pins on the Arduino Uno:

1. **Digital Pins:** The Arduino Uno has 14 digital input/output pins labeled from D0 to D13. These pins can be used for both **digital input** (reading sensors or switches) and **digital output** (controlling LEDs, relays, etc.). They can also be used for pulse-width modulation (PWM) output.
2. **Analog Pins:** There are 6 analog input pins labeled from A0 to A5. These pins can be used to read analog voltage levels from sensors or other analog devices. Note that the ATmega328P microcontroller on the Uno has a 10-bit analog-to-digital converter (ADC).
3. **Power Pins:**
4. **Vin:** This pin allows you to provide an external voltage source, such as from an external power supply, to power the Arduino.
5. **5V:** This pin provides a regulated 5V output, which can be used to power external components.
6. **3.3V:** This pin provides a regulated 3.3V output, suitable for powering some sensors and modules.

7. **GND:** There are several ground (GND) pins on the Arduino Uno, which are used as common ground connections for your circuits.
8. **RESET:** This pin is used to reset the Arduino. It can be connected to an external button or circuit for manual reset.
9. **TX (Transmit) and RX (Receive):** These pins are used for serial communication. They are often used for debugging and communication with other devices.
10. **ARef (Analog Reference):** This pin allows you to set an external reference voltage for the analog-to-digital converter.

It's important to note that some pins have multiple functions. For example, **pins 0 and 1 (RX and TX)** are used for serial communication with a computer or other devices when programming the Arduino, but they can also be used for **general digital I/O**.

When working with the Arduino Uno, it's essential to refer to the pinout diagram and documentation specific to your version of the board, as there are different variations of the Uno with slight differences in pin assignments and features.

2.2.3 Ultrasonic Sensor

Ultrasonic Sensor: It is an electronic device used to measure the distance between two objects or surfaces with the help of ultrasonic sound waves.

It consists of a transmitter to emit ultrasonic sound waves and a receiver that receives the sound waves which bounce back after hitting the object. An ultrasonic sensor is a device that uses sound waves at frequencies higher than the human ear can detect (typically above 20 kHz) to measure distances to nearby objects. It works on the principle of sending out short pulses of ultrasonic sound and then listening for the echo when those sound waves bounce off an object. By measuring the time, it takes for the sound waves to bounce back, the sensor can calculate the distance to the object based on the speed of sound in the air. Ultrasonic Sensor



Figure 2:ULTRASONIC SENSOR

2.2.4 LEDs

A Light Emitting Diode (LED) is a semiconductor device that emits light when an electric current passes through it. Made from materials like gallium arsenide, LEDs work by allowing electrons to recombine with holes when voltage is applied, releasing energy in the form of light. The color of the emitted light depends on the semiconductor material used. LEDs are highly efficient, converting much of the electrical energy into light rather than heat, making them ideal for various applications, including displays, indicators, and general lighting, thanks to their energy efficiency and long lifespan.



Figure 3:LED(Light Emitting Diode)

3.2.5 JUMPER WIRES

Jumper wires are a type of electrical wire used in electronics and prototyping projects to create connections between various components on a breadboard, PCB (printed circuit board), or other electronic platforms. They are typically flexible, insulated wires with connectors on both ends that can be easily plugged into or attached to electronic components.



Figure 4: Jumper Wires

TYPES OF JUMPING WIRES

Male and Female Ends

Jumper wires come in two main types: **male-to-male**, where both ends have pins, and **male-to-female**, where one end has pins and the other has sockets. This versatility allows you to connect different types of components.

CHAPTER 3: RESEARCH METHODOLOGY

3.0 INTRODUCTION

Research methodology is a systematic framework that guides the process of conducting studies, from formulating research questions to analyzing data. It encompasses the selection of appropriate methods for data collection and analysis, ensuring that findings are both reliable and valid. Key aspects include defining research objectives, choosing suitable techniques, and addressing ethical considerations. By adhering to rigorous methodologies, researchers can transform abstract ideas into empirical knowledge, contributing valuable insights to their fields. This foundational approach is crucial for producing credible and impactful research that advances understanding and informs further inquiry.

3.1 RESEARCH DESIGN

This study systematically investigates the effectiveness of the Car Parking Assistance System in enhancing parking efficiency and user experience in urban and residential settings.

Objective: To evaluate the significance of the Car Parking Assistance System in facilitating the identification of available parking spaces and reducing congestion.

Methods: The research employs a mixed-methods approach, utilizing online surveys distributed to a diverse sample of drivers. This will be followed by in-depth interviews with a selected group of participants to gain deeper insights into user perceptions and experiences.

Sampling: A random sampling strategy will be implemented, targeting drivers in both urban and suburban areas. The sample will be stratified based on factors such as location, age, and frequency of parking challenges to ensure a comprehensive representation of users.

Data Analysis: Quantitative data from surveys will be analyzed using statistical software to identify trends and patterns. Qualitative data from interviews will be thematically analyzed to explore the underlying attitudes and experiences of users regarding the parking assistance system.

Ethical Considerations: The study will adhere to ethical standards by obtaining informed consent from participants, ensuring confidentiality of their responses, and maintaining transparency throughout the research process. All findings will be reported in a manner that respects participant anonymity and integrity.

3.2 RESEARCH POPULATION

3.2.0. Target Population

- The target population for the Design and Implementation of the Car Parking Assistance System comprises all urban and suburban areas with high demand for parking management solutions. This includes:
 - **High-Traffic Locations:** Areas with dense traffic where locating available parking spaces is challenging, resulting in congestion and increased emissions. These locations may include commercial districts, shopping centers, and event venues where parking turnover is essential.
 - **Residential Areas:** Neighborhoods experiencing parking shortages due to high vehicle ownership, where residents often face difficulties finding available spaces. The system aims to alleviate the burden on residents and enhance overall parking efficiency.
 - **Public Infrastructure:** Parking facilities managed by local governments or transportation authorities that could benefit from improved occupancy detection and real-time information dissemination.

By focusing on these populations, the Car Parking Assistance System aims to address the pressing need for efficient parking solutions and enhance the overall user experience.

3.3 SAMPLE SIZE

The Car Parking Assistance System utilizes advanced technology, including ultrasonic sensors and LED indicators, to improve parking efficiency through real-time occupancy detection. The system is designed to help drivers quickly locate available parking spots, thereby reducing search time and congestion in urban and residential areas.

Key features include:

- **Ultrasonic Sensors:** Installed in each parking space to accurately detect vehicle presence.
- **LED Indicators:** Yellow and red lights signal whether a parking spot is available or occupied.

This project aims to implement a proactive approach to parking management, enhancing convenience for drivers and streamlining operations. The system represents a significant advancement in parking technology, providing reliable, real-time information to transform parking management practices.

3.3.1 Sampling Procedure

There are two major sampling procedures in research. These include probability and non-probability sampling. From these probability sampling is best for this project. There are four basic types of sampling procedures associated with probability samples. These include simple random, systematic sampling, stratified and cluster. From the sampling procedure Systematic Sampling Procedure is best for this project.

3.4 RESEARCH INSTRUMENT

The research instrument for the Design and Implementation of the Car Parking Assistance System comprises several key components essential for effective data collection and analysis:

Ultrasonic Sensors: These sensors are embedded in each parking space to measure the distance to vehicles accurately. They provide real-time data on whether a parking spot is occupied or available.

Control Unit: The central processing unit receives data from the ultrasonic sensors, analyzes it, and determines the status of each parking space. It manages the system's overall functionality and response.

LED Indicators: Each parking space is equipped with dual LED indicators—yellow for available spots and red for occupied ones. These indicators visually communicate the availability status to drivers.

User Feedback Mechanisms: Surveys and interviews with drivers are conducted to gather qualitative data on user experiences, perceptions of system effectiveness, and areas for improvement.

3.4.1 Choice of The Research Instrument

For the Design and Implementation of the Car Parking Assistance System, selecting the appropriate research instruments involves choosing the sensors and components that will effectively monitor parking space occupancy. Here's a guide to help you choose the research instruments for this project:

1. **Ultrasonic Sensors:** These sensors will be embedded in each parking space to measure the distance to any vehicle accurately. They ensure precise detection of whether a spot is occupied or available.

2. **Microcontroller:** An appropriate microcontroller, such as an Arduino Nano or Raspberry Pi, will be selected to process data from the ultrasonic sensors and control the LED indicators. These platforms are known for their versatility and ease of programming.
3. **LED Indicators:** Dual LED indicators (yellow and red) will be used for each parking space. The yellow LED will signal an available spot, while the red LED will indicate that the spot is occupied, providing immediate visual feedback to drivers.
4. **Power Supply:** A stable power supply is crucial for the operation of the sensors and microcontroller. This may involve using a DC power adapter or battery to ensure continuous functionality.
5. **Wiring and Connectors:** Appropriate wiring and connectors will be used to link the sensors, microcontroller, and LED indicators. Proper insulation and strain relief will be implemented to prevent electrical hazards and ensure reliability.

3.4.2 Validity and Reliability of The Instrument

Ensuring the validity and reliability of involves selecting sensors Which much with project goals, validating measurements against established standards, and confirming consistency through calibration and field tests. Internal consistency and test-retest reliability are essential for accurate data collection, while inter-rater reliability minimizes discrepancies in interpretation. Robustness to environmental factors and user feedback enhance the instrument's utility and effectiveness. By addressing these aspects, the system provides accurate and trustworthy information for monitoring and managing water pump operations in domestic settings, ensuring optimal functionality and resource management.

3.5 DATA GATHERING PROCEDURES

Data gathering for the Design and Implementation of the Car Parking Assistance System involves several key procedures. Firstly, ultrasonic sensors will be installed in each parking space to continuously monitor vehicle occupancy. Secondly, data on parking space usage patterns will be collected over a defined period to understand peak usage times and frequency of occupancy.

Thirdly, a logging system will be used to record sensor outputs and the status of each parking space in real time. This data will help in assessing the system's performance and identifying trends.

Additionally, surveys and interviews with drivers will be conducted to gather qualitative feedback on their experiences with the parking system, including usability, satisfaction, and any challenges faced.

Lastly, the collected data will be analyzed to evaluate the effectiveness of the Car Parking Assistance System, identify areas for improvement, and provide insights for optimizing parking management in urban and residential settings. Through this comprehensive approach, the project aims to enhance the overall parking experience and efficiency.

Here are the different methods used:

3.5.1 Interview

Conduct in-depth interviews with a sample of drivers to understand their perspectives, concerns, and expectations regarding the Car Parking Assistance System. Here are some questions used to collect data:

- How often do you encounter difficulties finding available parking spaces?
- What specific challenges do you face when searching for parking in busy areas?
- Have you experienced any frustration or delays due to unavailable parking spots?
- How important is real-time information on parking availability to you?
- What features would you find most useful in a parking assistance system?
- Do you have any concerns about the technology used in parking assistance solutions, such as reliability or privacy?
- How likely would you be to use a system that indicates parking availability through visual signals?

3.6 DATA ANALYSIS AND INTERPRETATION

Data analysis of the Car Parking Assistance System involves assessing usage patterns and system performance. Key metrics, such as parking space occupancy rates and frequency of vehicle turnover, are analyzed to optimize system functionality and enhance user experience.

The analysis focuses on identifying trends, such as peak parking times and the duration of occupancy, using data visualization and statistical techniques. This helps in pinpointing areas for improvement, such as reducing congestion during high-demand periods.

Insights gained from this analysis inform adjustments to the system, ensuring that accurate real-time information is provided to users. Additionally, feedback from users collected through surveys and interviews will be integrated into the analysis to enhance the system's usability and effectiveness.

Overall, the findings will guide refinements to the system's algorithms and user interface, promoting efficient management of parking spaces and improving the overall experience for drivers seeking available spots.

3.7 ETHICAL CONSIDERATIONS

Ethical considerations involve prioritizing user safety, privacy, and equitable access to resources. Ensure data security and privacy protection throughout data collection, storage, and transmission processes. Any type of communication in relation to the research should be done with honesty and transparency. Affiliations in any forms, sources of funding, as well as any possible conflicts of interests must be declared. Any deception or exaggeration about the aims and objectives of the research must be avoided. The protection of the privacy of research participants must be ensured. Any type of misleading information, as well as representation of primary data findings in a biased way must be avoided.

3.8 LIMITATIONS OF THE STUDY

The study of the Car Parking Assistance System faces several limitations that may impact its findings. These include potential sampling bias, as the selected parking locations may not represent the diversity of parking environments in urban and residential settings. Environmental factors, such as weather conditions and seasonal variations, can also affect sensor accuracy and data collection.

Technological disruptions, such as sensor malfunctions or connectivity issues, may lead to gaps in data and affect system reliability. Resource constraints, including budget limitations and availability of technology, may restrict the extent of implementation and testing.

Additionally, variations in user behavior, such as differing parking habits and levels of engagement with the system, can introduce inconsistencies in data quality. Ethical considerations around data privacy must be prioritized, ensuring that user information is handled responsibly.

By acknowledging these limitations and employing rigorous study design, comprehensive data collection methods, and transparent reporting, the study aims to enhance the integrity and applicability of its findings in real-world contexts.

CHAPTER 4: SYSTEM DESIGN, ANALYSIS AND IMPLEMENTATION

4.0. INTRODUCTION

The design and implementation of the Car Parking Assistance System is a technological solution aimed at streamlining the process of locating available parking spaces through real-time occupancy detection. With the increasing demand for efficient parking management solutions, this system addresses the challenges of finding available parking spots in both urban and residential settings. The Car Parking Assistance System integrates ultrasonic sensors and LED indicators to provide real-time information on parking space occupancy. Each parking spot is equipped with an ultrasonic sensor that measures the distance between the sensor and any vehicle, enabling precise detection of whether the space is occupied or available. Complementing this, dual LED indicators—green and red—are installed for each parking space. The yellow LED signals an available spot, while the red LED indicates that the spot is occupied. This visual feedback facilitates the quick identification of free parking spaces, thereby reducing the time spent searching and alleviating congestion in parking areas.

This chapter is structured into three main parts: system analysis, system design, and implementation. Each section elaborates on the interconnected processes that ensure the Car Parking Assistance System is effective, user-friendly, and robust.

4.1. CALCULATIONS

Data for Calculation:

To effectively monitor parking space availability using the Car Parking Assistance System, the following data is utilized:

- **Total Number of Parking Spaces:** 50
- **Number of Occupied Spaces Detected by Ultrasonic Sensors:** 30
- **Distance Measured by Ultrasonic Sensors (Occupied Spaces):** Average distance is not directly needed for occupancy calculations, but relevant for performance assessments.

Calculation of Available Parking Spaces:

To determine the number of available parking spaces, the calculation is as follows:

Available Parking Spaces=Total Number of Parking Spaces–Number of Occupied Spaces

Substituting the values:

Available Parking Spaces=50–30=20 which means we have only 20 available parking space this will indicated by 20LEDS in yellow color.

4.1.1 Distance calculation using ultrasonic sensor HC SR 04

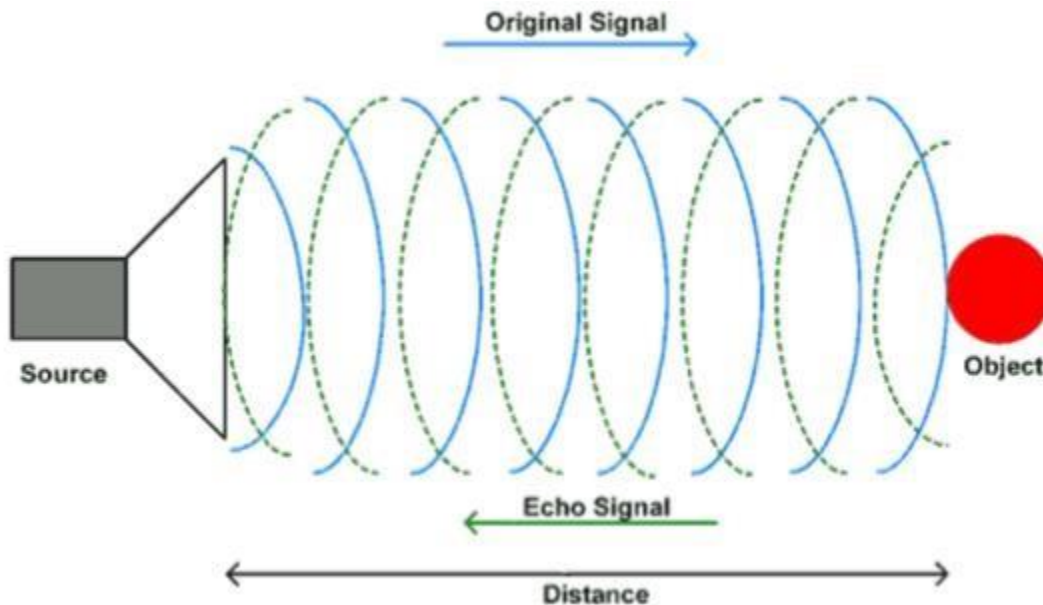

Figure 5: DISTANCE MEASURED BY ULTRASONIC

We know that

Distance = speed x time

The speed sound waves is 343m/s

So

Total distance = $343 \times \text{time of high (echo) pulse} / 2$

Total distance is divided by 2 because signal travels from HC-SR04 to object and returns to the module HC-SR-04.

Ultrasonic module timing diagram

1. we need to transmit a trigger pulse of at least 10 us to the HC-SR04 TRIG PIN.
2. then the ULTRASONIC SENSOR automatically sends 40khz sounds wave and wait for rising edge output at echo pin

3. then when the rising edge capture occurs at echo pin, start the timer, and wait for falling edge on echo pin

4.

4.As soon as the falling edge is captured at the Echo pin, read the count of the Timer. This time count is the time required by the sensor to detect an object and return from an object.

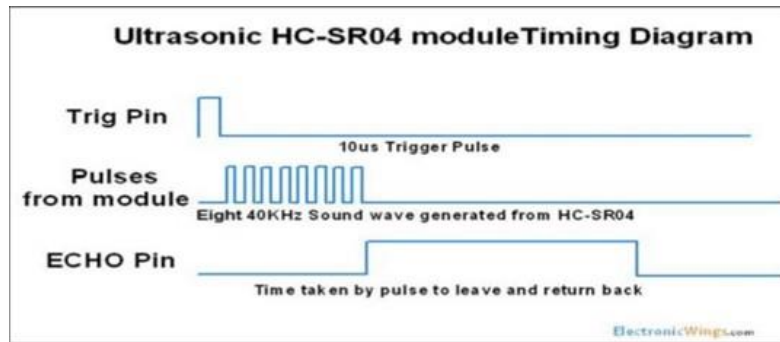
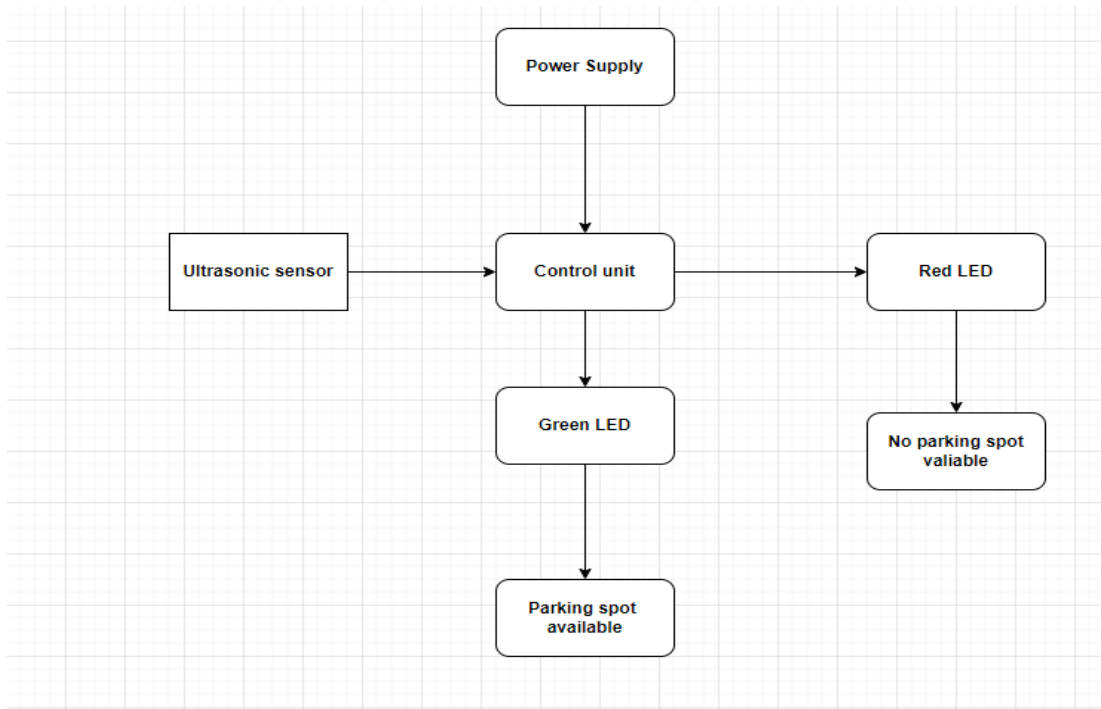
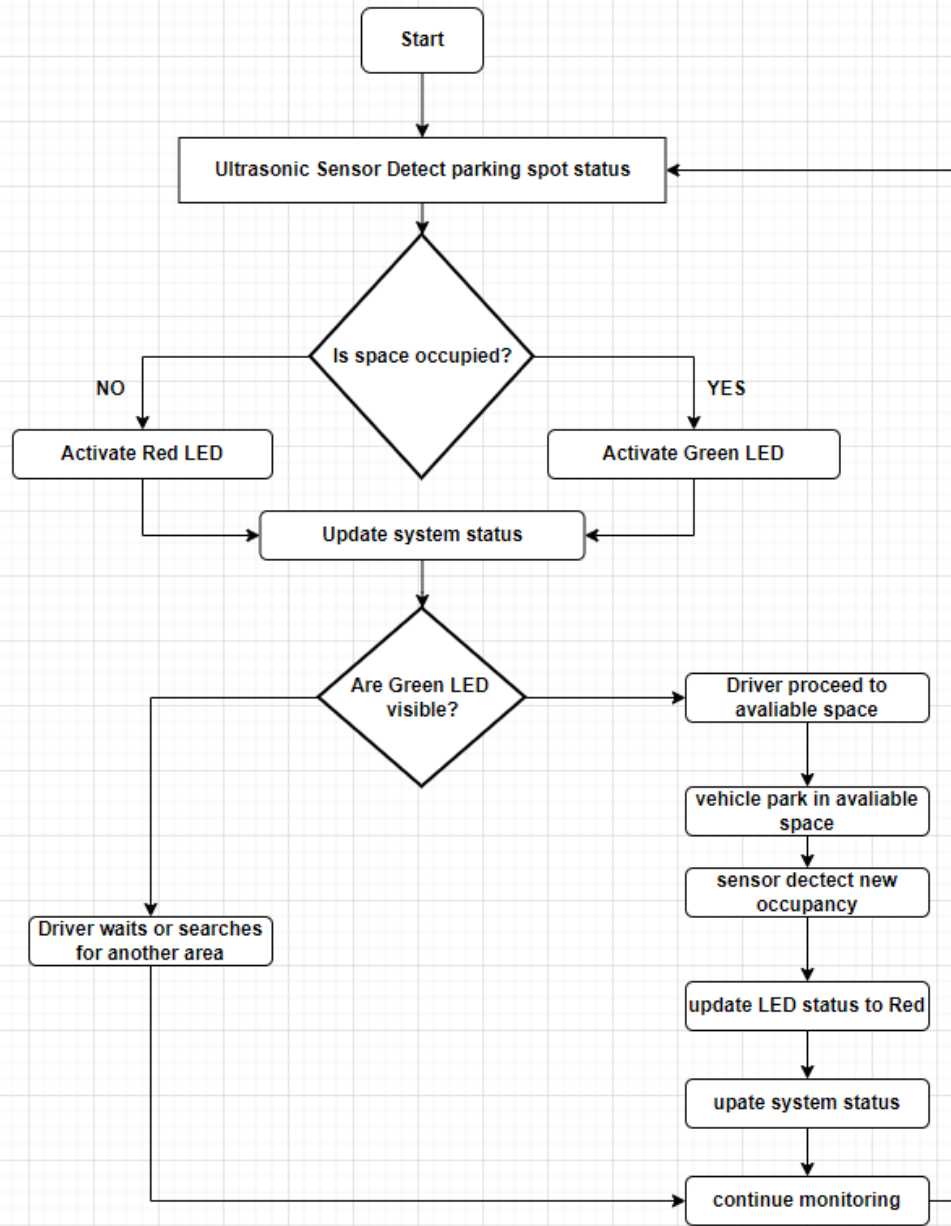

Figure 6:WAVE

4.1 DRAWINGS

4.1.0 Block Diagram





4.1.1 Flowchart

4.1.2 Circuit Diagram

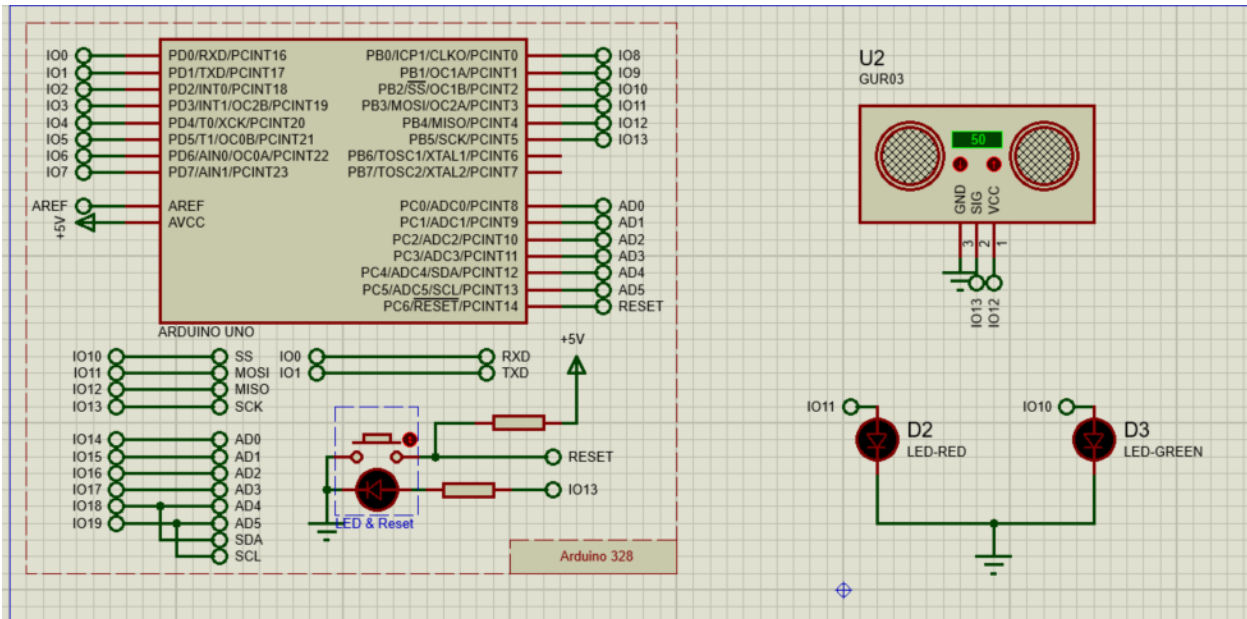

Figure 7 : circuit diagram

4.2 COST ESTIMATION

DEVICE	UNIT	PRICE/UNIT (RWF)	TOTAL (RWF)
Arduino Uno	1	20000	20000
Ultra Sonic	1	5000	5000
LEDs	8	200	1600
Jumper Wires	10	1500	15000
PCB	1	1500	1500
TOTAL			43100

Table 1 : Cost estimation

WORKING PRINCIPLE

The system's operation begins with the continuous monitoring of the car parking assistant using ultrasonic and strategically placed to detect if in parking spot there is a variable space for parking or not. When ultrasonic detect in parking spot is space for Yellow LED will indicate that space is not occupied so that car can park in (parking spot is empty driver can park) while ultrasonic detects car in parking spot red LED will indicate that parking spot is occupied so this orient drive to find another parking spot.

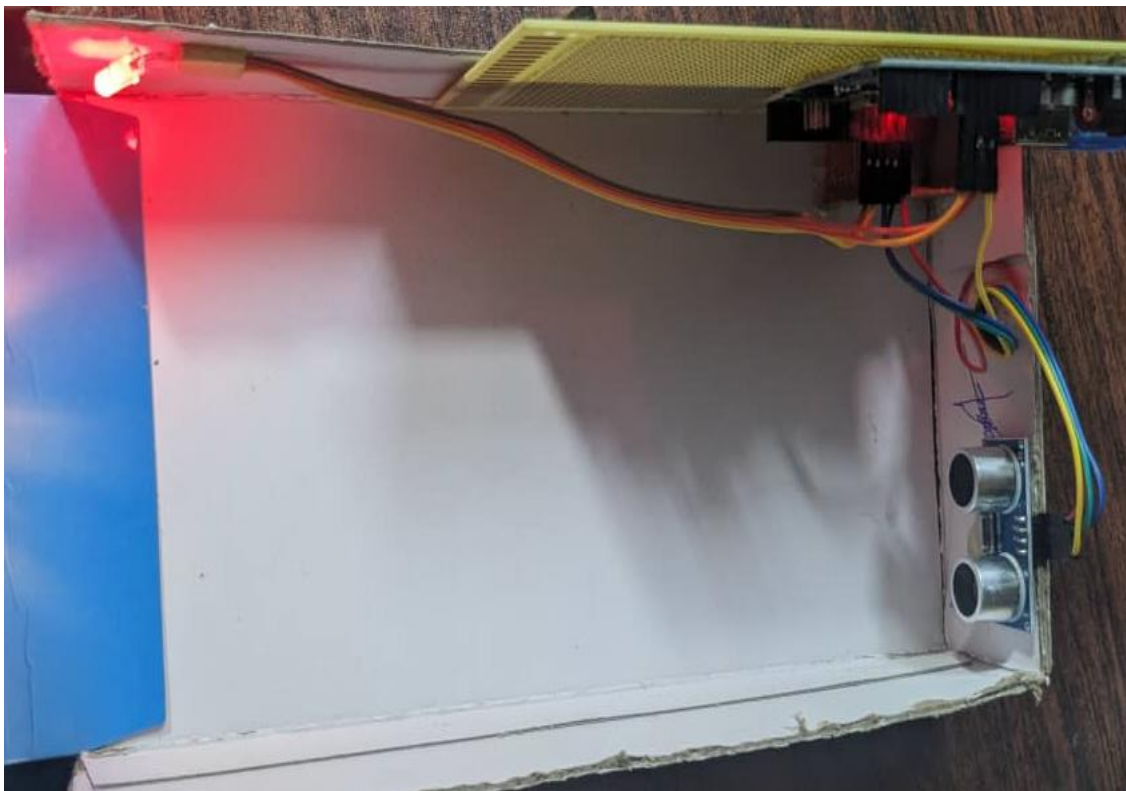

CHAPTER 5: CONCLUSION AND RECOMMENDATION

5.0. INTRODUCTION

The increasing demand for efficient parking management solutions has become a pressing issue due to the rising number of vehicles and the growing complexity of urban environments. Traditional parking systems often fail to address the challenges of locating available spaces effectively, leading to increased congestion and driver frustration. As highlighted, conventional methods rely heavily on static signage or manual operations, which do not provide real-time data on parking space availability. This inefficiency contributes to traffic congestion and reduced overall utilization of parking areas, underscoring the urgent need for advanced, technology-driven solutions. The Car Parking Assistance System presented in this project addresses these challenges through the integration of ultrasonic sensor technology with LED indicators. This system provides real-time, accurate information on parking space occupancy, significantly enhancing parking management. The ultrasonic sensors measure the distance to vehicles, ensuring precise detection of occupancy, while the LED indicators visually guide drivers to available spots.

Research has demonstrated that modern parking technologies improve efficiency and user satisfaction. The European Parking Association (EPA) and the International Transport Forum (ITF) emphasize the need for better parking management systems to alleviate congestion and enhance the overall driving experience.

5.1. CONCLUSIONS

The Design and Implementation of Car Parking Assistance System represents a significant advancement in parking management technology, addressing the pressing need for efficient space utilization in urban and residential environments. By leveraging real-time occupancy detection through ultrasonic sensors, the system ensures accurate and reliable identification of available parking spots. The integration of dual LED indicators enhances user experience by providing immediate visual feedback, allowing drivers to quickly locate free spaces and minimizing the time spent searching for parking. This innovative solution not only reduces congestion in parking areas but also contributes to more efficient traffic flow and improved satisfaction for users. Overall, the implementation of this system holds the potential to transform parking management practices, making them smarter and more user-friendly.

5.2. RECOMMENDATIONS

To maximize the effectiveness of the Car Parking Assistance System and further improve urban parking management, the following recommendations are proposed:

1. **Integration with Mobile Applications:** Develop a mobile application that provides real-time updates on parking availability, enabling drivers to reserve spots in advance. This can streamline the parking process further and reduce congestion around parking facilities.
2. **Collaboration with Urban Planning Authorities:** Work with local government and urban planners to incorporate the Car Parking Assistance System into broader smart city initiatives. This collaboration can ensure seamless integration with other transportation management systems.
3. **Regular Maintenance and Updates:** Establish a routine maintenance schedule for the ultrasonic sensors and LED indicators to ensure optimal performance. Continuous updates to the system software can also enhance functionality and user experience.
4. **Data Analytics for Improved Management:** Utilize data collected from the parking system to analyze usage patterns and trends. This information can guide parking policy decisions, such as dynamic pricing models or the allocation of resources for high-demand areas.
5. **User Education and Awareness Campaigns:** Implement educational initiatives to inform drivers about the new system's benefits and usage. Increasing awareness can facilitate quicker adoption and enhance overall user satisfaction.
6. **Scalability and Expansion:** Consider scaling the system to additional parking facilities, including public garages, commercial parking lots, and residential areas. A broader implementation can amplify the benefits observed in initial deployment areas.

5.3. SUGGESTIONS FOR FURTHER STUDY

- **Upgrade sensor technology:** Invest in advanced sensors like radar or laser to improve detection accuracy and reliability in the Car Parking Assistance System.
- **Enhance system integration:** Integrate the system with existing traffic management and urban infrastructure for better coordination and efficiency.

- **Implement regular maintenance:** Establish a routine for maintaining and calibrating sensors and LED indicators to ensure optimal performance over time.
- **Conduct comprehensive training:** Provide thorough training for parking area operators and users on operating and troubleshooting the system effectively.
- **Develop public awareness programs:** Educate the public about the system's features and safety measures to improve compliance and overall effectiveness.
- **Explore advanced features:** Consider adding functionalities such as real-time data analytics and remote monitoring to enhance system capabilities and user experience.
- **Review and upgrade technology regularly:** Stay updated with technological advancements to maintain system effectiveness, reliability, and safety standards.

REFERENCES

- Association, (. P., 2021. [Online]
Available at: [\(European Parking Association, 2021\)](#)
- Chen, Z., 2016. [Online]
Available at: [\(Z. Chen et al., 2016\)](#)
- formu, i. t., 2022. [Online]
Available at: <https://www.itf-oecd.org/full-publication>
- Forum, (. T., 2022. [Online]
Available at: [\(International Transport Forum, 2022\).](#)
- Glantz, D., 2009. [Online]
Available at: [\(D.M. Glantz, 2009\)](#)
- Gourley, J., 2013. [Online]
Available at: [\(J.J. Gourley et al., 2013\)](#)
- J.zheng, 2019. [Online]
Available at: [\(J. Zhang et al., 2019\)](#)
- M.john, 2020. [Online]
Available at: [\(M. Johnson & L. Smith, 2020\)](#)
- Parking, E., 2021. [Online]
Available at: <https://www.europeanparking.eu/>
- Patel, K., 2021. [Online]
Available at: [\(K. Patel et al., 2021\)](#)
- Resource, F., 2018. [Online]
Available at: [\(F. Resource et al., 2018\)](#)

APPENDIX

Appendices-A: code of the project

```
#define TRIG_PIN 13
#define ECHO_PIN 12
#define LED_PIN1 10
#define LED_PIN2 11
void setup() {
  // Initialize serial communication
  Serial.begin(9600);

  // Initialize pins
  pinMode(TRIG_PIN, OUTPUT);
  pinMode(ECHO_PIN, INPUT);
  pinMode(LED_PIN1, OUTPUT);
  pinMode(LED_PIN2, OUTPUT);
}

void loop() {
  // Parking spot variable
  long duration, distance;
  digitalWrite(TRIG_PIN, LOW);
  delayMicroseconds(2);
  digitalWrite(TRIG_PIN, HIGH);
  delayMicroseconds(10);
  digitalWrite(TRIG_PIN, LOW);

  duration = pulseIn(ECHO_PIN, HIGH);
  distance = (duration / 2) / 29.1; // Convert to cm

  // If car is detected (distance less than 10cm), turn on LED
```

```
if (distance < 10) {  
    digitalWrite(LED_PIN1, HIGH); // No Parcking spot variable  
    digitalWrite(LED_PIN2, LOW); // Parcking spot variable  
}  
else {  
    digitalWrite(LED_PIN1, LOW); // No Parcking spot variable  
    digitalWrite(LED_PIN2, HIGH); // Parcking spot variable  
}}
```