

DECLARATION A

I ASHUZA NDUSHA JEAN-BAPTISTE, Declare that the project report entitled “**IoT-Based Sunlight Tracking System, Case of study: HOPITAL GENERAL DE REFERENCE DE KADUTU**” is my original work and has not been presented for a Degree or any other academic award in any University or Institution of Learning. No part of this research should be reproduced without the authors consent or that of ULK Polytechnic Institute.

Student name: _____

Sign: _____ Date: _____

DECLARATION B

I confirm that the work reported in this project was carried out by the candidate under my supervisor and it has been submitted with my approval as the UPI supervisor.

Supervisor name: _____

Sign: _____ Date: _____

APPROVAL

This is to certify that the project “**IoT-Based Sunlight Tracking System**” is a record of the original work done and submitted by **ASHUZA NDUSHA JEAN-BAPTISTE**, Roll number: **202150359** to the ULK polytechnic institute in partial fulfillment of the requirement for award of advanced diploma (A1) in Electronics and Telecommunication has been examined and approved by the panel on oral examination.

Name and Sig. of Chairperson: _____

Date of Comprehensive Examination: _____

DEDICATION

I dedicate this work to the infallible God almighty, who lives forever and from whom all comes to me
To my father BANYWESIZE NDUSHA and my mother BAHATI NTAMBALA I dedicate this piece
of work too.

To my sister IRENE ANSIMA NDUSHA

To my supervisor and lectures,

And to all friends and colleagues I dedicate this work.

ACKNOWLEDGEMENT

The biggest gratitude goes to the one and only God who lives forever, he cares about us, he gives us unconditional love and overwhelming protection for us from the beginning till now.

I'm so thankful to ULK POLYTECHNIC INSTITUTE, for the hands-on skills, attitude and knowledge. My specific thanks to those lecturer NIYONKURU Jaddas and MUSHIMIYIMANA Jean Damascene for what they give me for better future, founder and president of ULK Ltd Pr. Dr. RWIGAMBA BALINDA.

Thank you so much my supervisor Eng. Steven BIRALI without him; nothing could be done his advices, recommendations, correction and support that take a huge contribution in my work.

I'm deeply grateful to my Father BANYWESIZE NDUSHA and my mum BAHATI NTAMBALA who helped me financially, morally and in prayers to fulfill this work. I'm so thankful to my siblings as well who encourage me and never abandoned me.

My gratitude for the knowledge I got from different people my friends as well who helped me fulfilling this precious work, especially LEON, ARNOLD, ALFREDO, ARMAND, ROMY, VICKY, GAEL, PATRICK, ARSENE, ARIANE, SADATE, URBAIN, RIPHIN and so one, they were a big to achieve my goal.

I really appreciate your support God bless you abundantly.

ABSTRACT

This project presents the development of an IoT-based sunlight tracking system designed to optimize solar energy capture by dynamically adjusting the orientation of solar panels. Utilizing four Light Dependent Resistors (LDRs) for real-time sunlight detection, the system employs two servo motors to adjust the panel's position on both horizontal and vertical axes. The integration of Internet of Things (IoT) technology facilitates effective management of the system's output based on weather conditions; when the weather is favorable, both important and non-essential LEDs are activated, while only the important LED is illuminated during adverse weather conditions. These LEDs are representing the part of the installation which needs currently to be supplied and the one which can be out of current without any damage. This approach not only enhances the efficiency of solar energy generation but also provides users with real-time monitoring capabilities through an OLED display and a web interface. The findings demonstrate that the IoT-enabled solar tracking system can significantly improve energy output and reliability, contributing to the broader adoption of renewable energy solutions.

List of Figures

Figure 1: Comparison of single-axis and dual-axis solar tracking systems	19
Figure 2: Main parts of an ESP 32	20
Figure 3: Solar panel	21
Figure 4: OLED Display	22
Figure 5: Battery	23
Figure 6: LDR main parts	23
Figure 7: Servo-motor	24
Figure 8: Arduino UNO	24
Figure 9: Illustration of a dual-axis solar tracking mechanism	26
Figure 10: Illustration of an IoT-based renewable solar energy system.....	27
Figure 11: Circuit diagram of an IoT-Based solar tracking system.....	41
Figure 12: Bloc diagram of an IoT-Based solar tracking system	42
Figure 13: Flow chart of an of an IoT-Based solar tracking system	44
Figure 14: Implementation of the Final year project.....	45

LIST OF ABBREVIATIONS:

IoT: Internet of Things

LDR : Light Dependent Resistor

LED: Light Emitting Diode

OLED: Organic Light Emitting Diode

LCD: Liquid Crystal Display

WiFi: Wireless Fidelity

API: Application Programming Interface

GPIO: General Purpose Input/Output

IC: Integrated Circuit

VCC: Voltage at the Common Collector

GND: Ground

PWM: Pulse Width Modulation

PCB: Printed Circuit Board

EMI: Electromagnetic Interference

RTC: Real-Time Clock

I2C: Inter-Integrated Circuit

PWM: Pulse Width Modulation

IDE: Integrated Development Environment

ULK: Universite Libre de Kigali

B/W CCD : Black and White Charge-Coupled Device.

Contents

DECLARATION A	I
DECLARATION B	II
APPROVAL.....	III
DEDICATION.....	IV
ACKNOWLEDGEMENT.....	V
ABSTRACT	VI
List of Figures.....	VI
LIST OF ABBREVIATIONS:.....	VII
CHAPTER 1: GENERAL INTRODUCTION	1
1.0. Introduction	1
1.1. Background to the study.....	1
1.2. Problem statement	2
1.3.Research objectives	3
1.3.1 Main Objective: Develop an IoT-Enabled Solar Energy Management System:	3
1.3.2 Specific Objectives:.....	3
1.4 Research Questions	4
1.5 Scope and Limitations of the Study.....	4
Scope:	4
Limitations:.....	4
1.6 Significance of the Study.....	5
1.7. Organization of the project	6
CHAPTER 2: LITERATURE REVIEW	7
2.1 Introduction	7
2.2 Concepts, Opinions, and Ideas from Authors/Experts.....	7
2.2.1 Overview of Sunlight Tracking Technologies	7
2.2.2 Advancements in IoT-based Renewable Energy Systems	8
2.2.3 Components used.....	8
2.2.3 Challenges and Opportunities in Integrating IoT with Solar Tracking	13
2.3 Theoretical Perspectives	13
2.3.1 Maximizing Solar Energy Capture through Dual-Axis Tracking.....	13
2.3.2 IoT-enabled Monitoring and Optimization of Solar Energy Systems	14
2.4 Related Studies	15
2.4.1 IoT-Enabled Dual-Axis Solar Tracking System with Weather-Based Output Management.....	15
2.4.2 Solar Optimization Devices for Improved Efficiency	16

2.4.3 Overcoming Challenges in Solar Energy Systems through Solar Optimization	16
2.4 CHAPTER CONCLUSION	16
CHAPTER 3: RESEARCH METHODOLOGY	18
3.1. Introduction	18
3.2. Research Design	18
3.3. Research population	19
3.4. Sample Size	19
3.5. Research Instrument	20
3.5.1 Choice of the research instrument	20
3.5.2 Validity and Reliability of the Instrument	21
3.6. Data Gathering Procedures	22
Quantitative component:	22
Qualitative component:	22
3.7. Data Analysis and interpretation	23
Quantitative analysis:	23
Qualitative analysis:	23
3.8. Data Analysis and interpretation	23
3.9. Ethical considerations	24
CHAPTER 4: SYSTEM CONCEPTUALIZATION, ANALYSIS AND REALIZATION	26
4.1. Introduction	26
4.2. Computations	26
4.3. Working principal	27
4.5. Diagrams	29
4.5.1 Circuit Diagram	29
4.5.2 Block diagram	31
4.5.3 Flow chart	32
4.5.4 Implementation	33
4.5. Parameters	33
4.6. Cost Estimation	34
4.7. Realization	34
4.7.1 Assembly	34
4.7.2 Programming	34
4.7.3 Testing	35
4.7.4 Final Adjustments	35
CHAPTER 5: CONCLUSION AND RECOMMENDATIONS	36

5.1.Introduction	36
5.2.Conclusion.....	36
5.3. Recommendations:	37
5.4. Suggestions for further study.....	38
References	39
APPENDICES:	40
Appendice A:code of the Sunlight tracking system	40
Appendice B: Code of the IoT controller	41

CHAPTER 1: GENERAL INTRODUCTION

1.0. Introduction

Solar energy is one of the most promising renewable energy sources due to its abundance, sustainability, and environmental friendliness. However, the efficiency of solar panels is significantly influenced by their orientation relative to the sun. Traditional solar panels are often fixed in a single position, which limits their energy output throughout the day as the sun's position changes.

To enhance energy generation, sunlight tracking systems have been developed to automatically adjust the panel's orientation based on the sun's position. However, this project introduces an innovative approach by integrating the Internet of Things (IoT) to manage the output of the solar energy system based on real-time weather data.

This IoT-based sunlight tracking system focuses on optimizing the use of solar energy by allowing the important components of the installation to operate under both good and adverse weather conditions. In contrast, non-essential components will only be activated during favorable weather, ensuring efficient energy utilization. By continuously monitoring environmental factors such as temperature and humidity, the system can make informed decisions on when to operate the non-essential components, thus minimizing energy loss.

The integration of IoT technology enables real-time data analysis, allowing for effective management of energy output based on current weather conditions. This approach not only maximizes the energy output of solar panels but also enhances the reliability and efficiency of solar energy systems. Ultimately, the project aims to contribute to the broader adoption of renewable energy solutions by making solar energy more accessible, efficient, and cost-effective.

1.1. Background to the study

Sunlight tracking systems have been extensively studied and implemented using various approaches, including mechanical, electro-mechanical, and microcontroller-based systems. These systems typically utilize light sensors, motors, and control algorithms to detect the sun's position and adjust the solar panel accordingly. One of the earliest sunlight tracking systems was developed by (McFee,

2020) which employed an open-loop control approach with an error margin of 0.5 to 1 degree. Since then, significant advancements have been made in sunlight tracking technologies, with closed-loop control systems utilizing four-quadrant photodetectors and CCD cameras achieving tracking errors as low as 0.01 to 0.2 degrees (Arka360, 2023)

Despite these advancements, many existing sunlight tracking systems lack the capability for remote monitoring and control, making it challenging to optimize their performance and diagnose issues. The emergence of the Internet of Things (IoT) has opened up new possibilities for enhancing sunlight tracking systems by enabling real-time data monitoring, remote control, and predictive maintenance. This project focuses on an IoT-based sunlight tracking system that manages the output of solar energy installations based on real-time weather data. The system ensures that important components operate under both good and adverse weather conditions, while non-essential components are activated only during favorable weather (Arkresources, 2023)

By integrating weather data, the system can optimize energy output while minimizing energy loss. For instance, when environmental conditions are unfavorable, the system can adjust the operation of non-essential components to enhance overall efficiency. This IoT integration allows for real-time data analysis, enabling predictive maintenance and performance optimization. Ultimately, this approach aims to significantly improve the energy output of solar panels, making solar energy more accessible, efficient, and cost-effective, thereby contributing to the broader adoption of renewable energy solutions.

1.2. Problem statement

The efficiency of solar energy systems is significantly impacted by the orientation of solar panels relative to the sun, with fixed installations unable to adapt to the sun's movement throughout the day. This limitation leads to substantial energy losses, particularly during peak sunlight hours. Traditional sunlight tracking systems have been developed to address this issue by dynamically adjusting the orientation of solar panels. However, these systems often lack the capability to manage energy output based on real-time weather conditions.

The increasing demand for renewable energy sources necessitates a more intelligent approach to solar energy capture. This project proposes an IoT-based sunlight tracking system that not only follows the sun's position but also manages the output of solar energy installations based on current weather conditions. By integrating real-time data on environmental factors such as temperature, humidity, and sunlight intensity, the system will optimize the use of important components under both favorable and adverse weather conditions. Non-essential components will only be activated during good weather, ensuring efficient energy utilization and minimizing waste.

1.3. Research objectives

1.3.1 Main Objective: Develop an IoT-Enabled Solar Energy Management System:

Create a system that effectively manages the output of solar energy installations based on real-time weather data, ensuring optimal performance under varying environmental conditions.

1.3.2 Specific Objectives:

a) Design a sunlight tracker respecting Weather-Responsive Energy Management System:

- Develop a system that dynamically adjusts automatically solar panel and respect the operation of essential and non-essential components based on current weather conditions, allowing important parts of the installation to function in both good and adverse weather.

b) Establish Weather-Based LED Management:

- Control LED indicators based on weather conditions, ensuring that essential indicators are illuminated during adverse weather while both important and non-essential indicators are activated during favorable conditions.

c) Enhance Energy Efficiency and Reliability:

- Aim for increased energy capture and output by optimizing the operation of solar energy components based on real-time weather data and predictive analytics for maintenance and performance.

d) Facilitate Remote Monitoring and Control:

- Enable remote access to the system for monitoring and control, allowing users to make informed decisions regarding energy management based on current and forecasted weather conditions.

1.4 Research Questions

- a) How can integrating IoT technology enhance the real-time monitoring and optimization of weather-responsive solar energy management systems?
- b) How effective are IoT-based predictive analytics in managing the energy output of solar energy systems under varying weather conditions?
- c) What are the potential benefits of IoT-enabled weather-responsive solar energy management systems in terms of energy efficiency, reliability, and cost-effectiveness?
- d) How can IoT integration improve the resilience and adaptability of solar energy systems to adapt to changing weather patterns and environmental conditions?

1.5 Scope and Limitations of the Study

Scope:

The scope of this project encompasses the development of an IoT-based sunlight tracking system that integrates real-time environmental monitoring to optimize the performance and efficiency of solar energy generation. Key aspects of the project include the design and implementation of a dual-axis solar tracking mechanism that can adjust the orientation of solar panels in both the azimuth (horizontal) and elevation (vertical) directions. The system will utilize IoT-enabled microcontrollers to control and collect real-time data on environmental conditions such as temperature and humidity. The system will also manage the output of solar energy installations, ensuring that important components operate under both favorable and adverse weather conditions, while non-essential components are activated only during good weather.

Limitations:

The project faces several limitations, including challenges associated with the installation and maintenance of the IoT-based sunlight tracking system. These challenges include ensuring environmental durability, maintaining communication reliability, and achieving cost-effectiveness. The energy consumption of the IoT-based tracking system will also be evaluated, particularly its impact on the overall energy efficiency of solar power generation and output management. A comprehensive cost-benefit analysis will be conducted to assess the economic viability of the system compared to

traditional solar panel installations. Furthermore, we will ensure that the solar tracking system complies with relevant regulations and safety standards in the target market or region of deployment. Finally, the integration of various IoT components may introduce complexities in system design and operation that need to be addressed to ensure seamless functionality.

1.6 Significance of the Study

The development of an IoT-based sunlight tracking system for solar panels is crucial in the pursuit of sustainable and efficient renewable energy solutions. This study aims to address the limitations of existing solar tracking systems by leveraging IoT technologies to enhance the performance and management of solar energy generation based on real-time weather data.

Solar Energy Providers and Installers: The proposed system can significantly improve the energy generation efficiency of solar panels by optimizing their operation according to current weather conditions. This leads to increased power output and cost savings for solar energy providers and end-users, particularly in maximizing energy capture during favorable weather.

Renewable Energy Policymakers and Government Agencies: The research findings will inform the development of more effective policies and incentives to promote the adoption of advanced solar tracking technologies. By demonstrating the benefits of IoT integration in solar energy systems, this study supports the transition towards a greener and more sustainable energy landscape.

Researchers and Technology Developers: This study will expand the knowledge base in the field of IoT-enabled solar tracking systems, providing a foundation for further research and innovation. The insights gained can inspire the development of more sophisticated, intelligent, and user-friendly solar tracking solutions that incorporate real-time weather data for optimized performance.

Households and Communities: The improved efficiency and remote monitoring capabilities of the proposed system can make solar energy more accessible and affordable, particularly for households and communities in remote or off-grid locations. This contributes to enhanced energy security and a better quality of life by ensuring reliable energy access.

Overall, the integration of IoT technology into sunlight tracking systems represents a significant advancement in optimizing solar energy generation. By enabling intelligent management based on weather conditions, this study not only enhances the efficiency of solar energy systems but also promotes the broader adoption of renewable energy solutions, supporting the transition towards a sustainable energy future.

1.7. Organization of the project

This project has five chapters ranging from chapter one until five

-The **chapter one** talks about the reason which motivates us to develop this system according to the existing problem, we introduce the project, background of the project, problem statement, general objective and significance of the project.

-The **chapter two**, the literature review is discussed. The discussion will be made much more on the definitions of key words, Examining existing sunlight tracking technologies and advancements in IoT-based renewable energy systems.

-The **chapter three**, talks about the methodology chosen for designing the project, detailing the design of the solar tracking mechanism, the IoT-enabled control and monitoring system, and the performance optimization algorithms.

-The **chapter four**, Here we are showing the implementation of the sunlight tracking system performance, energy generation improvements, and insights from IoT-enabled monitoring and control.

-The **chapter five**, which is conclusion and recommendations; In this point which is the last part of the project we conclude.

CHAPTER 2: LITERATURE REVIEW

2.1 Introduction

The global demand for renewable energy sources, particularly solar power, has been steadily increasing in recent years. This growth has underscored the necessity for innovative technologies that can enhance the efficiency and performance of solar energy systems. A notable advancement in this field is the integration of the Internet of Things (IoT) with sunlight tracking systems. This literature review aims to provide a comprehensive overview of existing research, concepts, and theoretical perspectives related to IoT-based sunlight tracking systems that not only follow the sun but also monitor real-time environmental conditions such as rain, humidity, and temperature. Additionally, the review will explore the potential benefits and challenges associated with this approach.

2.2 Concepts, Opinions, and Ideas from Authors/Experts

2.2.1 Overview of Sunlight Tracking Technologies

Sunlight tracking systems have been extensively studied and developed to optimize the performance of solar energy systems. These systems can be classified into two main categories: single-axis and dual-axis tracking.

Single-axis tracking systems adjust the orientation of solar panels along a single axis, either in the azimuth (horizontal) or elevation (vertical) direction. These systems are relatively simpler and more cost-effective but provide less optimization compared to dual-axis systems (**Arkresources, 2023**).

Dual-axis tracking systems, on the other hand, adjust the orientation of solar panels in both azimuth and elevation directions, allowing for more precise tracking of the sun's movement throughout the day. These systems can increase the energy output of solar panels by up to 40% compared to fixed or single-axis systems (**Arkresources, 2023**).

Single-Axis vs. Dual-Axis Solar Tracking

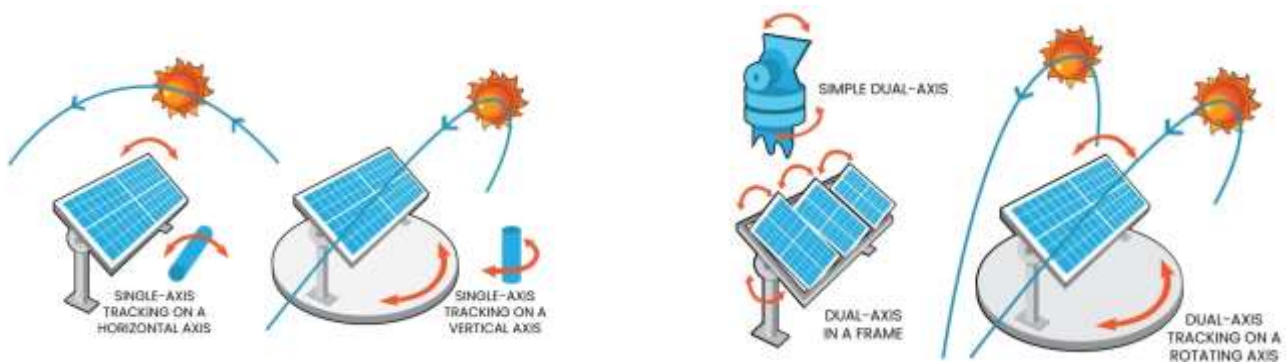

Figure 1: Comparison of single-axis and dual-axis solar tracking systems

(paste.txt)

According to (Arka360, 2023), the optimal placement and orientation of solar panels are crucial factors in maximizing the energy production of a solar system. Factors such as tilt angle, azimuth alignment, and avoiding shading can significantly impact the system's performance.

2.2.2 Advancements in IoT-based Renewable Energy Systems

The integration of IoT technologies in renewable energy systems has gained significant attention in recent years. IoT-enabled devices can collect real-time data on various parameters, such as solar irradiance, panel angles, and environmental conditions, and transmit this data to a central platform for analysis and optimization (Arka360, 2023)

(Gnetek, 2023) highlights the benefits of IoT integration in solar energy systems, including the ability to overcome challenges such as shading, mismatch, and aging, which can reduce the output of solar panels. IoT-based monitoring and control systems can help improve the efficiency and reliability of solar energy systems by enabling remote monitoring, predictive maintenance, and optimization based on environmental conditions.

Experts emphasize the potential of IoT-based renewable energy systems to facilitate the integration of solar energy with other renewable sources and smart grid technologies, contributing to a more comprehensive and efficient energy ecosystem (Arka360, 2023).

2.2.3 Components used

1. ESP32 Microcontroller:

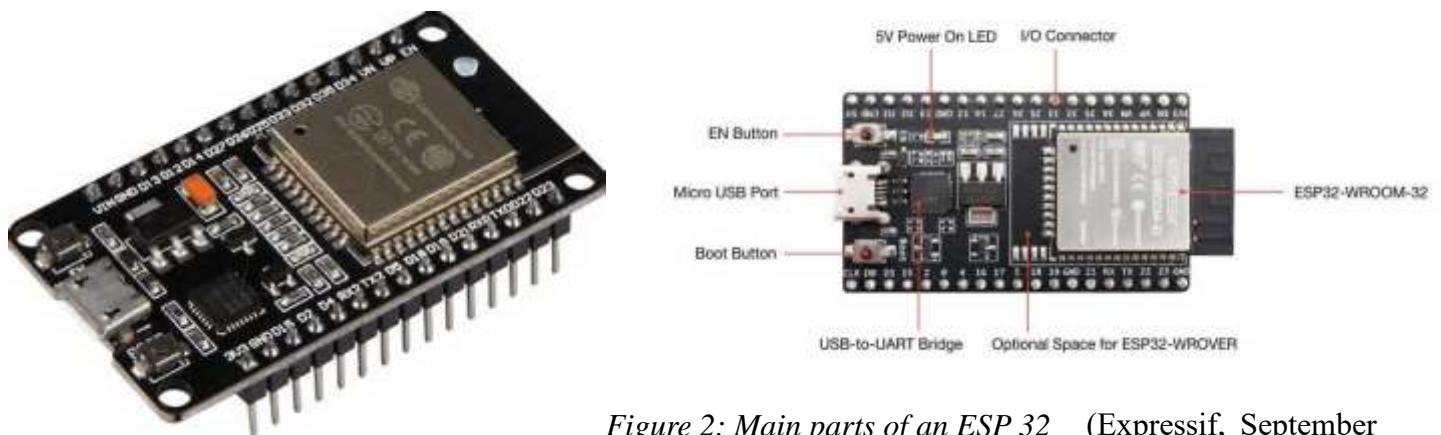

Figure 2: Main parts of an ESP 32 (Expressif, September 6, 2016)

-The ESP32 is a powerful, low-power, dual-core microcontroller with built-in Wi-Fi and Bluetooth connectivity.

- It has 30 GPIO pins, 12-bit SAR ADCs, two DACs, and various other peripherals that make it well-suited for IoT applications.

- The ESP32 will serve as the main control unit for the solar tracking system, reading sensor inputs, controlling the servo motors, and communicating with the IoT gateway.

- It can be programmed using the Arduino IDE or the ESP-IDF (Espressif IoT Development Framework) using C/C++ or the Lua programming language.

2. Solar Panel:

- The 5W solar panel is the main power source for the solar tracking system.



Figure 3: Solar panel

(History, 1983)

- It converts sunlight into electrical energy, which is then used to power the ESP32, servo motors, and other components.

- Solar Panel: The solar panel used in this project is a high-efficiency monocrystalline solar panel. Monocrystalline solar panels are made from a single crystal of silicon, which allows for a higher level of purity and efficiency. They typically have an efficiency rating of 15-22%, making them one of the most

e.

Why chosen: The monocrystalline solar panel was chosen for this project because of its high efficiency

and durability. It will provide a reliable and consistent source of energy for the solar tracking system, ensuring that the system operates efficiently and effectively. Additionally, the monocrystalline solar panel is a popular choice for solar tracking systems due to its high efficiency and ability to withstand harsh environmental conditions.

- The solar panel's output is connected to a charge controller to regulate the voltage and current.

3.OLED Display

An OLED (Organic Light-Emitting Diode) display is a type of display technology used in various electronic devices. It consists of a thin, flexible, and lightweight panel that emits light from organic compounds when an electric current is applied. Here are the key points about OLED displays:

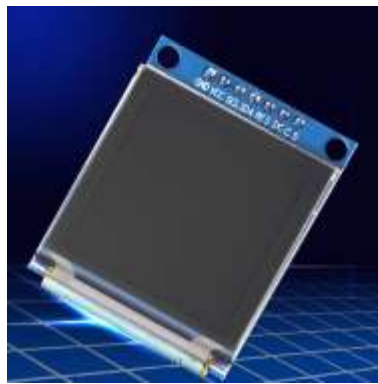

Figure 4: OLED Display

(Laborator, 1983)

- Structure: An OLED display consists of a layer of organic compounds sandwiched between two electrodes. The organic compounds emit light when an electric current is applied.
- Advantages: OLED displays offer high contrast ratios, wide viewing angles, and fast response times. They are also thinner and lighter than traditional LCD displays.
- Applications: OLED displays are commonly used in smartphones, smartwatches, and other portable devices due to their flexibility and high pixel density.
- Disadvantages: OLED displays are more prone to burn-in and have a shorter lifespan compared to LCD displays.

4. Battery



Figure 5: Battery
(Preroom, 1994)

- The battery stores the electrical energy generated by the solar panel.
- It provides power to the system during periods of low sunlight or at night.
- The battery is connected to the charge controller's output and the system's power supply.
- The battery is a 3.7V

4. Light Dependent Resistors (LDRs):

- LDRs, also known as photoresistors, are light-sensitive devices that change their resistance based on the amount of light incident on them.

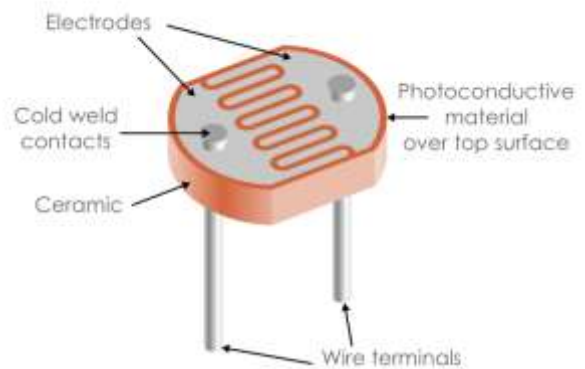

Figure 6: LDR main parts

(Verma, January 17, 2022)

- In the solar tracking system, LDRs will be placed on different sides of the solar panel to detect the direction of the sun's rays.

- The ESP32 will read the analog values from the LDRs and use them to determine the optimal orientation of the solar panel.

5. Servo Motors:

- Servo motors are rotary actuators that allow for precise control of angular position, velocity, and acceleration.



Figure 7: Servo-motor

(Circuitdigest, August 1, 2015)

6. ARDUINO UNO:



Figure 8: Arduino UNO

(Arduino.cc, 2010)

- In the solar tracking system, servo motors will be used to physically tilt and rotate the solar panel to align it with the sun's position.
- The ARDUINO will control the servo motors by sending pulse-width modulation (PWM) signals to adjust the panel's orientation.

2.2.3 Challenges and Opportunities in Integrating IoT with Solar Tracking

While the integration of IoT with solar tracking systems offers significant potential benefits, there are also challenges that need to be addressed. These include the development of reliable and cost-effective IoT devices, the implementation of secure communication protocols, and the integration of data analysis and optimization algorithms (Gnetek, 2023).

Opportunities for further research and development include the use of advanced technologies such as artificial intelligence and machine learning to optimize the performance of IoT-based solar tracking systems, and the exploration of new applications and business models enabled by the integration of IoT in renewable energy systems (Arka360, 2023).

2.3 Theoretical Perspectives

2.3.1 Maximizing Solar Energy Capture through Dual-Axis Tracking

The theoretical foundation for the use of dual-axis solar tracking systems lies in the principle of maximizing the capture of solar energy throughout the day. By continuously adjusting the orientation of solar panels in both the azimuth and elevation directions, dual-axis tracking systems can ensure that the panels are always positioned at the optimal angle to receive the maximum amount of solar radiation (Arkresources, 2023)

The mathematical models and algorithms used to control the movement of dual-axis tracking systems are based on the principles of solar geometry and the calculation of the sun's position relative to the solar panels. These models take into account factors such as the time of day, the latitude and longitude of the installation site, and the tilt and orientation of the solar panels (Boulder, 2023).

Dual-Axis Solar Tracking Mechanism

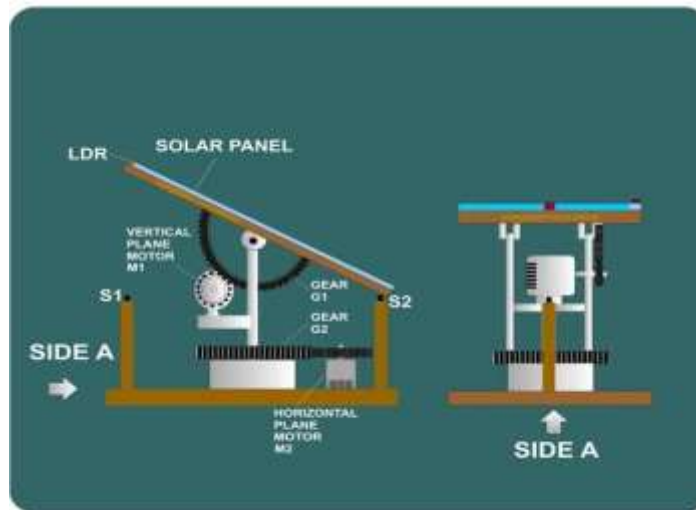

Figure 9: Illustration of a dual-axis solar tracking mechanism (MDPI, March,29 2024)

2.3.2 IoT-enabled Monitoring and Optimization of Solar Energy Systems

The integration of IoT technologies in solar energy systems is grounded in the theoretical principles of real-time data collection, analysis, and optimization. IoT-enabled devices can continuously monitor various parameters, such as solar irradiance, panel angles, and environmental conditions, and transmit this data to a central platform for analysis (Arka360, 2023).

The theoretical foundations of IoT-based optimization include the use of algorithms and machine learning techniques to identify patterns, predict system performance, and optimize the operation of solar energy systems. By leveraging the real-time data and advanced analytics capabilities of IoT platforms, solar energy systems can be fine-tuned to maximize energy production, improve reliability, and reduce maintenance costs (Gnetek, 2023).

IoT-based Solar Energy Optimization

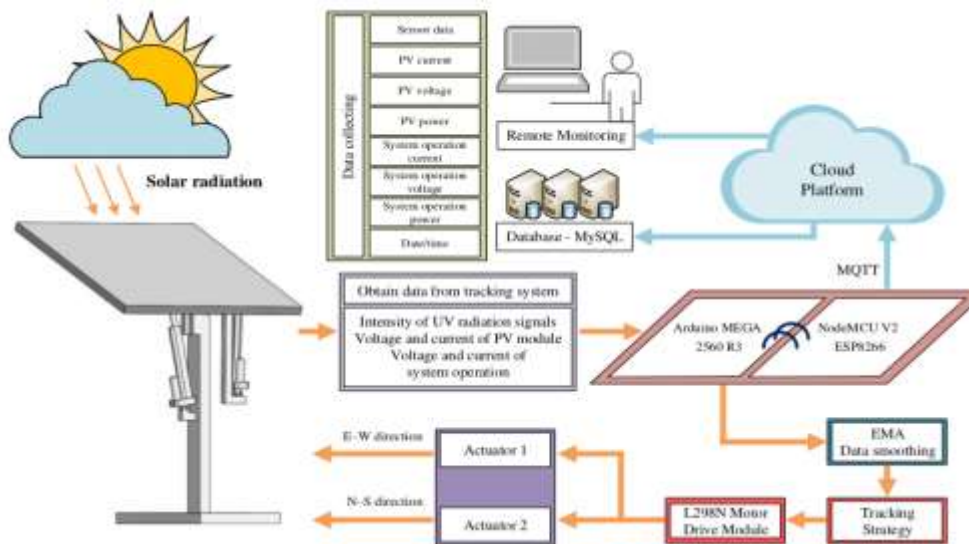

Figure 10: Illustration of an IoT-based renewable solar energy system (Sciencedirect, 2023)

2.4 Related Studies

2.4.1 IoT-Enabled Dual-Axis Solar Tracking System with Weather-Based Output Management

A study by (Arkresources, 2023) explored the development of an IoT-enabled dual-axis solar tracking system that not only adjusts the orientation of solar panels to follow the sun's movement but also manages the output based on real-time weather data. We are designe and implementing a prototype system that could continuously optimize the panel position while collecting data on solar irradiance, panel angles, and environmental conditions such as temperature, humidity, and rain.

The system is designed to prioritize the operation of important components during unfavorable weather conditions, while activating non-essential components only when environmental conditions were suitable. This approach ensured efficient energy utilization and minimized waste, contributing to the overall reliability and cost-effectiveness of the solar energy system.

2.4.2 Solar Optimization Devices for Improved Efficiency

Another related study by (Gnetek, 2023) focused on the use of solar optimization devices, such as DC optimizers and microinverters, to enhance the efficiency and reliability of solar energy systems. These devices are designed to overcome challenges like shading and mismatch, which can reduce the output of solar panels.

The study found that by using DC optimizers or microinverters in conjunction with a dual-axis tracking system and IoT-based weather monitoring, the overall efficiency of the solar energy system can be further improved. These devices can independently manage the output of each solar panel, ensuring that the system operates at its maximum potential even under partially shaded conditions or when panels experience mismatch due to aging or other factors.

The combination of dual-axis tracking, IoT integration, weather-based output management, and solar optimization devices represents a comprehensive approach to maximizing the efficiency and reliability of solar energy systems. By addressing various challenges and leveraging advanced technologies, this approach can contribute to the widespread adoption of solar power as a reliable and cost-effective renewable energy solution.

2.4.3 Overcoming Challenges in Solar Energy Systems through Solar Optimization

(Gnetek, 2023) investigated the use of solar optimization devices, such as module-level power electronics (MLPEs), to address the challenges faced by solar energy systems. The study examined the benefits of solar optimization, including the ability to mitigate the effects of shading, mismatch, and aging on solar panel performance.

The researchers highlighted the different types of solar optimization devices, such as discrete DC optimizers, smart panels, and microinverters, and provided guidance on selecting the most suitable option based on factors such as budget, shading conditions, safety concerns, and system size and configuration.

2.4 CHAPTER CONCLUSION

In summary, the combination of IoT technologies with dual-axis solar tracking systems, along with effective output management based on weather data, presents significant potential for optimizing solar

energy generation performance and efficiency, thereby encouraging the broader adoption of renewable energy solutions.

CHAPTER 3: RESEARCH METHODOLOGY

3.1. Introduction

This chapter presents the research methodology employed in this study. It outlines the research design, the target population, the sampling procedure, the research instrument, the data gathering process, the data analysis techniques, the ethical considerations, and the limitations of the study. The chapter aims to provide a detailed and systematic approach to addressing the research questions and achieving the objectives of the study.

3.2. Research Design

This study employs a mixed-methods approach, combining both quantitative and qualitative research methods. The quantitative aspect involves conducting a cross-sectional survey to gather data from the target population at a specific point in time. This design is suitable as it aims to explore the relationships between various factors, particularly how the integration of Internet of Things (IoT) technology with solar tracking systems relates to the factors influencing their adoption and performance.

On the qualitative side, the study includes semi-structured interviews, which follow a guided set of questions while allowing for flexibility to delve deeper into specific topics. This mixed-methods strategy is adopted to achieve a more comprehensive understanding of the research problem. By collecting and analyzing data from multiple sources—surveys and interviews—the study aims to provide a fuller perspective and validate the findings.

The qualitative interviews are conducted with a subset of survey respondents to gain deeper insights into their perceptions, experiences, and opinions regarding the integration of IoT with solar tracking systems. By utilizing this mixed-methods approach, the study aspires to deliver robust and reliable findings that can inform the successful integration of IoT technologies with solar tracking systems in the renewable energy sector.

3.3. Research population

The target population for this study consists of individuals and organizations involved in the renewable energy, particularly those working with solar energy technologies at HOPITAL GENERAL DE REFERENCE DE KADUTU. The population is geographically located in Bukavu.

This research population is also target to Bboxx,a companies which are using renewable energy and which are in this business include this technology for providing an improvement for the old system used until now in Bukavu city.

3.4. Sample Size

To determine the appropriate sample size for the quantitative component of this study, we are using the Yamane (1967) formula:

$$n = N / (1 + N(e)^2) \quad (4)$$

Where:

n = sample size

N = total population size

e = margin of error (expressed as a decimal)

$$e = 5\% \text{ of } 200 = 0.05$$

$$n = 200 / (1 + 200(0.05)^2)$$

$$n = 200 / (1 + 0.5)$$

$$n = 133,3$$

Rounding up, the recommended sample size is 134

Sampling Procedure

The study will utilize a stratified random sampling technique to ensure a representative sample of the target population. Participants will be grouped into strata based on organization type (e.g., solar energy companies, system integrators, researchers) and geographic location, with random samples selected from each stratum.

Stratified random sampling is ideal for representing diverse subgroups within a heterogeneous population. This method ensures that the sample accurately reflects the target population's characteristics. Random selection minimizes selection bias allowing for generalizable findings, provided the sample size is adequate and strata are well-defined.

For the qualitative aspect, purposive sampling will be employed to select interview participants based on their expertise and willingness to provide detailed insights. This approach will ensure a variety of perspectives regarding the integration of IoT with sunlight tracking systems that monitor real-time environmental conditions.

3.5. Research Instrument

The primary data collection instruments for this study is a structured questionnaire and a semi-structured interview guide.

The questionnaire is designed to gather information on the respondents' perceptions, attitudes, and experiences related to the integration of IoT with solar tracking systems. It will consist of several sections, each addressing a specific aspect of the research questions. The sections will cover demographic information, awareness and knowledge of IoT technologies, factors influencing adoption, performance and effectiveness of IoT-based solar tracking systems, challenges and barriers to integration, and open-ended questions for additional insights.

The semi-structured interview guide will be used to conduct in-depth interviews with a subset of the survey respondents. The guide will include a list of open-ended questions and probes that will allow the researcher to explore the research problem in more depth and gather rich, contextual data. The interviews will be conducted in a conversational manner, allowing the interviewees to share their experiences, opinions, and insights freely.

3.5.1 Choice of the research instrument

The questionnaire was chosen as the primary data collection instrument for the quantitative component of the study because it allows for the collection of numerical data that can be analyzed using statistical methods. It enables the researcher to reach a larger sample size in a cost-effective and efficient manner, and the structured format ensures consistency in data collection across all respondents .

The semi-structured interviews were selected for the qualitative component because they provide an opportunity to gather in-depth insights and explore the nuances of the research problem. The interviews allow the researcher to probe deeper into the respondents' experiences, opinions, and perspectives, and to gather rich, contextual data that can complement the findings from the quantitative component.

The choice of these research instruments is consistent with the mixed-methods approach adopted in this study. By combining quantitative and qualitative data, the researcher aims to provide a more comprehensive understanding of the research problem and to triangulate the findings from multiple sources.

3.5.2 Validity and Reliability of the Instrument

To ensure the validity and reliability of the research instruments, the following measures will be taken:

Validity:

- The questionnaire and interview guide will be reviewed by a panel of experts in the field of renewable energy and IoT to assess the content validity and ensure that the items accurately measure the constructs of interest.
- A pilot study will be conducted with a small sample of the target population to further refine the instruments and address any ambiguities or issues.
- Construct validity will be assessed by examining the correlations between the questionnaire items and the theoretical constructs they are intended to measure. Convergent and discriminant validity will be evaluated using factor analysis techniques.

Reliability:

- Test-retest reliability will be evaluated by administering the questionnaire to a subset of the sample twice, and examining the correlation between the two sets of responses.
- The interviews will be recorded, transcribed, and coded by multiple researchers to ensure consistency in the interpretation of the data.

The expert review of the questionnaire and interview guide will help to ensure that the items are clear, unambiguous, and relevant to the research questions. The pilot study will provide an opportunity to test the instruments in a real-world setting and make any necessary adjustments before the main data collection phase.

3.6. Data Gathering Procedures

The data for this study will be collected through the following steps:

Quantitative component:

- Obtaining the necessary approvals and permissions from the relevant authorities and organizations to conduct the study.
- Contacting the selected participants and providing them with information about the study, including the purpose, the voluntary nature of participation, and the confidentiality of the responses.
- Administering the questionnaire to the participants online through a secure web-based platform.
- Ensuring that the participants provide informed consent before participating in the study.
- Collecting the completed questionnaires and storing the data in a secure and confidential manner.

Qualitative component:

- Identifying potential interviewees based on their expertise, experience, and willingness to provide in-depth insights into the research problem.
- Contacting the selected interviewees and scheduling the interviews at a time and location convenient for them.
- Conducting the interviews using the semi-structured interview guide, allowing for flexibility and probing to gather rich, contextual data.
- Recording and transcribing the interviews to ensure accuracy and facilitate data analysis.
- Storing the interview data in a secure and confidential manner.

3.7. Data Analysis and interpretation

The data collected through the questionnaire and semi-structured interviews will be analyzed using a combination of quantitative and qualitative techniques.

Quantitative analysis:

- Coding and entering the questionnaire data into a statistical software package, such as SPSS or R.
- Conducting descriptive statistics to summarize the demographic characteristics of the sample and the responses to the questionnaire items.
- Performing inferential statistical analyses, such as correlation analysis, regression analysis, and analysis of variance (ANOVA), to examine the relationships between the variables of interest and test the hypotheses.
- Interpreting the results of the statistical analyses in the context of the research objectives and the existing literature.
- Presenting the findings in a clear and organized manner, using tables, figures, and narrative explanations.

Qualitative analysis:

- Transcribing the interview recordings and preparing the data for analysis.
- Coding the interview data using a thematic analysis approach, identifying key themes and patterns that emerge from the data.
- Interpreting the coded data in the context of the research objectives and the existing literature, identifying key insights and findings.
- Triangulating the qualitative findings with the quantitative results to provide a more comprehensive understanding of the research problem.
- Presenting the qualitative findings in a narrative format, using illustrative quotes and examples to support the key themes and insights.

3.8. Data Analysis and interpretation

We will examine the magnitude and direction of the relationships between variables, as well as the statistical significance of the findings. The results will be discussed in the context of the theoretical framework and the practical implications for the renewable energy sector.

The presentation of the quantitative findings will include descriptive statistics, such as means, standard deviations, and frequencies, to summarize the characteristics of the sample and the responses to the questionnaire items. Inferential statistics, such as correlation coefficients, and regression coefficients will be presented to illustrate the relationships between variables and the statistical significance of the findings. Tables and figures will be used to present the data in a clear and concise manner, while narrative explanations will be used to provide context and interpretation.

The coded data will be interpreted in the context of the research objectives and the existing literature on IoT and solar tracking technologies. Key insights and findings will be identified, and illustrative quotes and examples will be used to support the themes. The qualitative findings will be triangulated with the quantitative results to provide a more comprehensive understanding of the research problem.

The presentation of the qualitative findings will be in a narrative format, organized around the key themes that emerge from the data. Illustrative quotes and examples will be used to support the themes and to provide a rich, contextual understanding of the research problem. The qualitative findings will be integrated with the quantitative results to provide a holistic understanding of the integration of IoT with solar tracking systems and the factors influencing their adoption and performance.

3.9. Ethical considerations

- Obtaining informed consent from all participants and ensuring the voluntary nature of their participation.
- Protecting the confidentiality and anonymity of the participants by not collecting any personally identifiable information and storing the data securely.
- Minimizing any potential risks or harm to the participants and ensuring their well-being throughout the study.
- Obtaining the necessary approvals from the institutional review board or ethics committee before commencing the data collection.
- Providing participants with the opportunity to withdraw from the study at any time without any consequences.

-Ensuring the accurate and honest reporting of the research findings, without any falsification or misrepresentation of the data.

Ethical considerations are crucial in any research study, as they help to protect the rights and well-being of the participants and ensure the integrity of the research process[(Babbie, 2016).]. By adhering to ethical principles, the researcher can build trust with the participants and ensure that the study is conducted in a responsible and accountable manner.

CHAPTER 4: SYSTEM CONCEPTUALIZATION, ANALYSIS AND REALIZATION

4.1. Introduction

This chapter presents the detailed conceptualization, analysis, and realization of the project. It outlines the computations performed, the diagrams created, the parameters established, and the cost estimation for the project. Additionally, it discusses the implementation process, which may vary depending on the specific requirements of the project. The aim is to provide a comprehensive understanding of how the system was conceived and the rationale behind the choices made.

4.2. Computations

In this section, we outline the key computations that were performed to ensure the system meets the desired specifications and performance criteria.

-Solar panel

$$P= 8W$$

$$V=5V$$

$$I= 1.6A$$

-ESP32

$$P=V*I$$

(2)

$$V=3.3V, I_{Max}=638Ma$$

$$P= V*I = 3.3V *638*10^{-3}$$

$$P=2105.4mW$$

-ARDUINO UNO

$$V=5V$$

$$I=500mA$$

$$P=5V*500mA= 2500mW$$

-OLED DISPLAY

$$V=3.3V$$

$$I=20mA$$

$$P= 3.3V*20mW=66mW$$

-LCD With I2C

$$V=5V$$

$$I=20mA$$

$$P=20mA*5V=100mW$$

-LEDs

$$V=3.3V$$

$$I=40mA$$

$$P=3.3V*40mA=132mW$$

-SERVO-MOTORS

$$V=5V$$

$$I=0.5A$$

$$P=0.5A*5V=2.5mW$$

4.3. Working principal

The IoT-based sunlight tracking system operates on a dual-axis mechanism that optimizes solar energy capture by adjusting the orientation of solar panels according to the sun's position throughout the day. The system employs four LDRs to detect sunlight intensity from different directions, enabling it to determine the sun's position in real-time. The system is using two microcontrollers:

- The ARDUINO microcontroller processes the readings from the LDRs to determine the direction of the sun. It calculates the differences in light intensity between the LDRs to decide how to adjust the solar panel's position. If one LDR receives significantly more light than its counterpart, the microcontroller sends a command to the corresponding servo motor to adjust the panel's angle toward the brighter LDR then,

- The ESP32 connects to the internet via WiFi to fetch real-time weather data from an external API (OpenWeatherMap). This data includes temperature and humidity, which the system uses to assess whether the environmental conditions are favorable for solar energy generation. The system controls two LEDs based on weather conditions. When the weather is good (e.g., temperature above 22 degrees), both the important and non-essential LEDs are activated. Conversely, during adverse weather conditions, only the important LED is illuminated, signaling the system's operational status. during the nighttimes the ESP32 microcontoller should allow all LEDs to turn ON, here, the weather will not be the cause of decision because there in not charge but only discharge or utilization of energy stored.

Two servo motors are used: one for horizontal movement and another for vertical movement. The microcontroller sends commands to these motors based on the processed LDR data, allowing the panel to track the sun's movement across the sky.

- The OLED and LCD displays show relevant information such as weather conditions, battery voltage, and system status, allowing users to monitor the performance of the solar tracking system easily.

4.4.Specifications

Components	specifications
ESP32 Development Board	<ul style="list-style-type: none"> - Microcontroller: Xtensa 32-bit LX6 dual-core processor - CPU Speed: Up to 240 MHz - RAM: 520 KB - Flash Memory: 4 MB to 16 MB (depending on the model) - Connectivity: Wi-Fi (802.11 b/g/n) and Bluetooth (4.2) - GPIO Pins: 34 (varies by board)
Light Dependent Resistors (LDRs)	<ul style="list-style-type: none"> Microcontroller: Xtensa 32-bit LX6 dual-core processor - CPU Speed: Up to 240 MHz - RAM: 520 KB - Flash Memory: 4 MB to 16 MB (depending on the model) - Connectivity: Wi-Fi (802.11 b/g/n) and Bluetooth (4.2) - GPIO Pins: 34 (varies by board)
Servo Motors	<ul style="list-style-type: none"> Type: Standard servo (e.g., MG995 or SG90) - Operating Voltage: 4.8V to 6V - Torque: 9 kg/cm (for MG995) or 2.5 kg/cm (for SG90) - Rotation Range: 180 degrees
OLED Display	<ul style="list-style-type: none"> Type: 0.96-inch OLED display (I2C) - Resolution: 128x64 pixels - Operating Voltage: 3.3V to 5V - Interface: I2C (typically address 0x3C)
Arduino UNO	<ul style="list-style-type: none"> -Microcontroller: ATmega328P

	<ul style="list-style-type: none"> -CPU Speed: 16 MHz -RAM: 2 KB -Flash Memory: 32 KB -Digital I/O Pins: 14 (6 PWM) -Analog Input Pins: 6 -Operating Voltage: 5V
Resistors	<ul style="list-style-type: none"> Value: 10 kΩ (for LDR voltage divider) - Power Rating: 0.25 W - Tolerance: $\pm 5\%$
Battery	<ul style="list-style-type: none"> Type: Lithium-ion or Lithium Polymer (LiPo) - Voltage: 3.7V nominal - Capacity: Typically 2000 mAh or higher (depending on application) - Connector: JST or similar

4.5. Diagrams

This section includes the schematic diagrams and layout diagrams that illustrate the system conceptualization.

4.5.1 Circuit Diagram

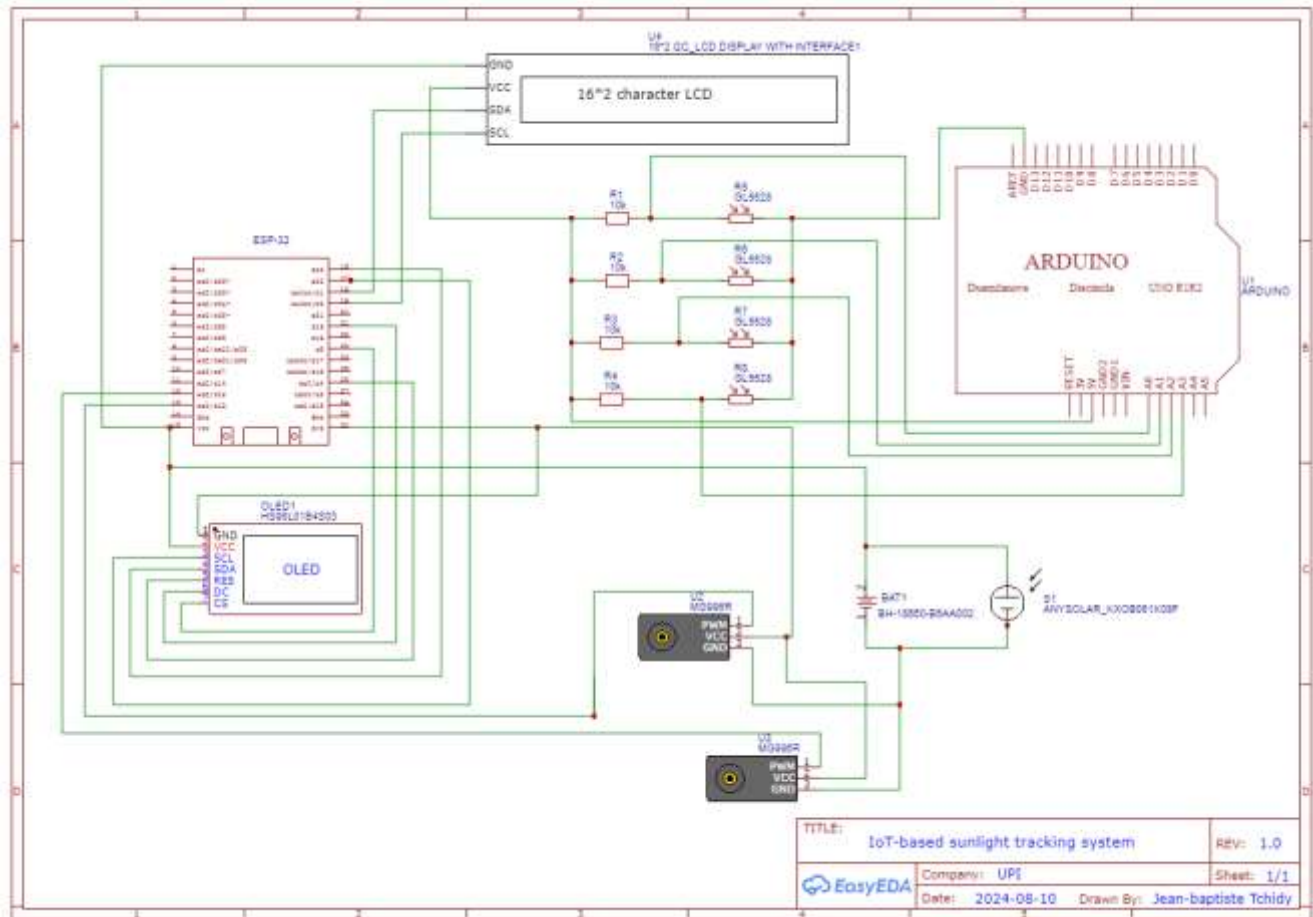

Figure 11: Circuit diagram of an IoT-Based solar tracking system

4.5.2 Block diagram

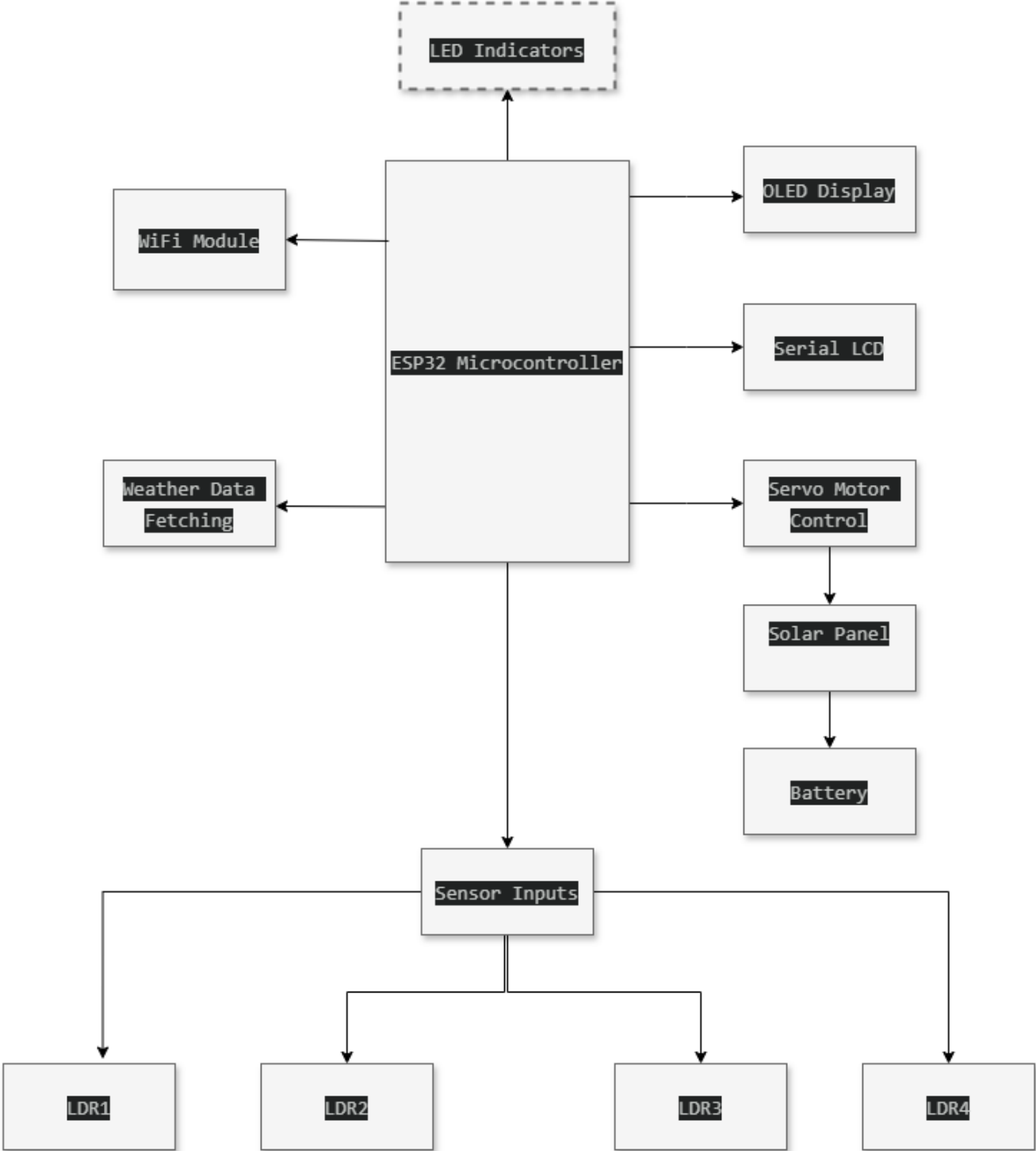

Figure 12: Bloc diagram of an IoT-Based solar tracking system

4.5.3 Flow chart

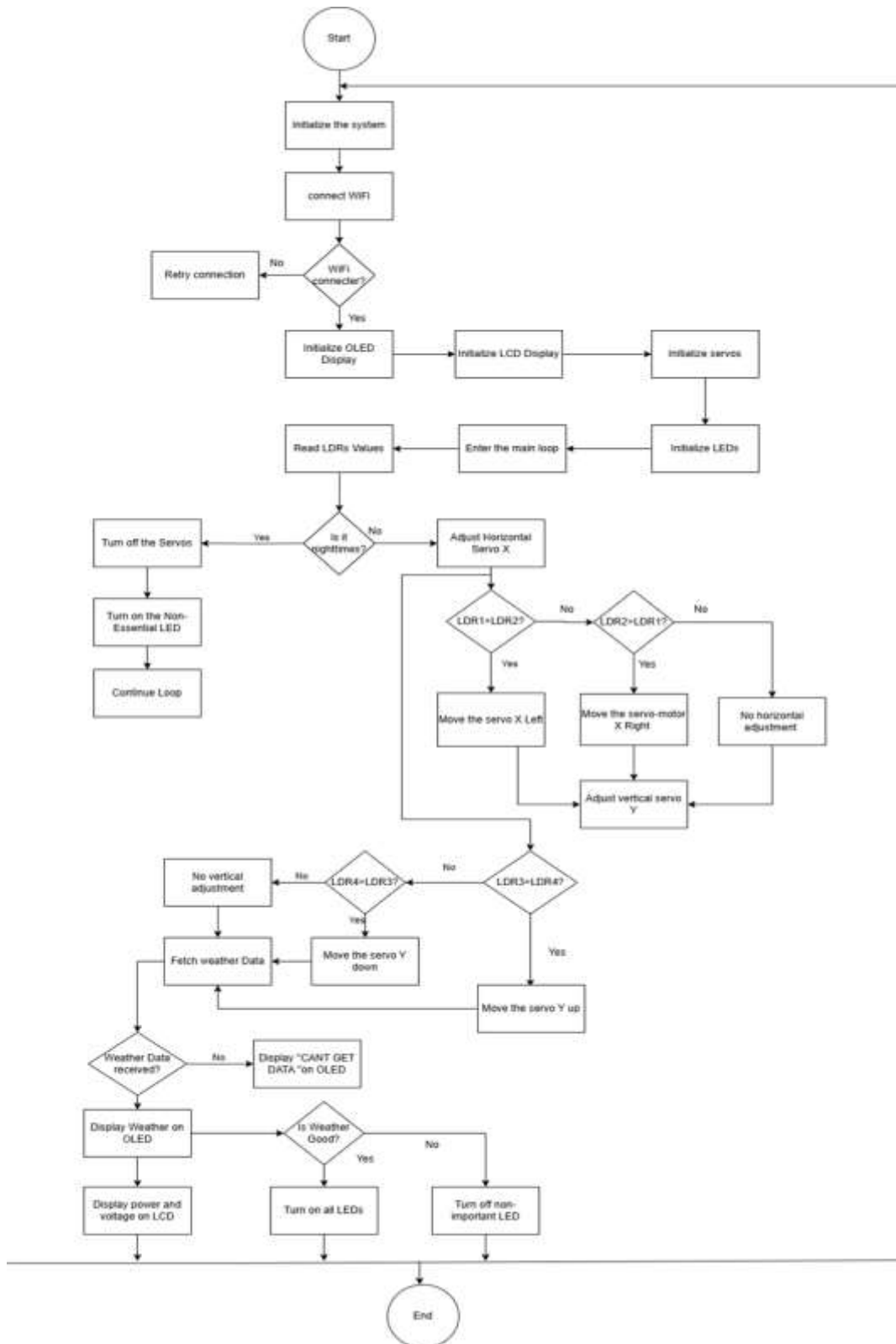
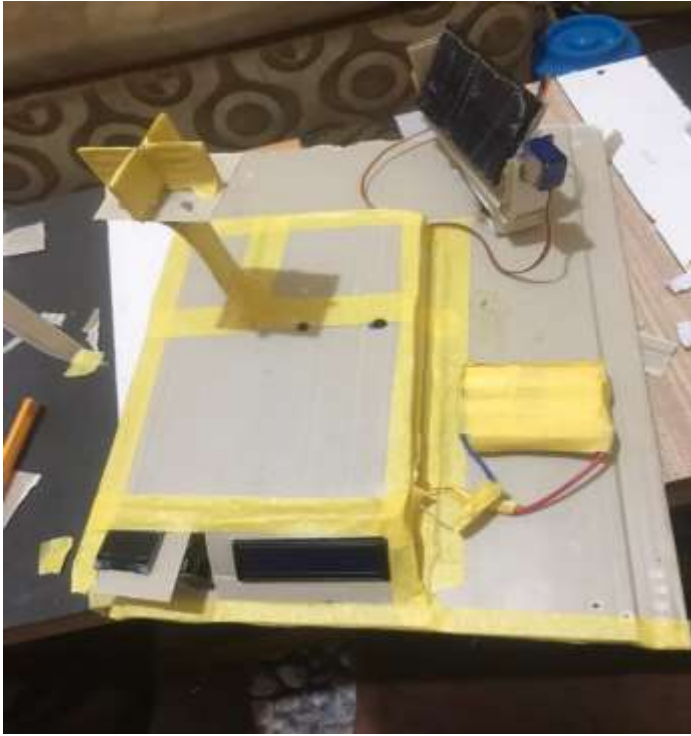

Figure 13: Flow

chart of an of an IoT-Based solar tracking system

4.5.4 Implementation



project

Figure 14: Implementation of the Final year

4.5. Parameters

The parameters define the operational variables and features of the system. The following parameters were established:

- Power Supply:
- Voltage: 9V DC
- Current: 2A
- Operating Temperature:
- Minimum: -10°C
- Maximum: 50°C
- Communication Protocol:
- I2C for sensor communication
- Wi-Fi for remote monitoring
- Response Time:
- Maximum allowable response time: 200 ms
- Data Accuracy:

- Measurement accuracy: $\pm 2\%$

4.6. Cost Estimation

This section outlines the projected expenses related to the project:

Item	Quantity	Unit Cost (\$)	Total Cost (\$)
Microcontroller (ESP32)	1	17	17
Microcontroller (Arduino UNO)	1	15	15
Sensors (LDRs)	4	0.5	2
LCD with I2C	1	8	8
Servo Motor	2	5	10
OLED Display	1	8	8
Resistors and Capacitors	6	0.5	3
PCB Fabrication	2	1	2
Solar panel	1	5	5
Battery	1	5	5
Miscellaneous			10
Total Estimated Cost(\$)			90

4.7. Realization

4.7.1 Assembly

- We connected all parts together following the wiring schematic. To ensure correct functionality, we connected each component carefully.

4.7.2 Programming

-We use the Arduino Integrated Development Environment (IDE) for the coding. we uploaded to the ESP32, ensuring that the system could read sensor data and control the servo motor effectively.

4.7.3 Testing

- After assembly the system we tested to verify that all components were functioning as expected. This included checking the response time, data accuracy, and overall performance.

4.7.4 Final Adjustments

- Based on the test results, any necessary adjustments were made to the code or hardware configuration to optimize performance and ensure that the system met the specified requirements.

CHAPTER 5: CONCLUSION AND RECOMMENDATIONS

5.1.Introduction

This chapter summarizes the key findings of the study and presents the conclusions drawn from the analysis of the data. It also provides recommendations for future research and practical implications for the integration of IoT with solar tracking systems in the renewable energy sector.

5.2.Conclusion

The integration of IoT with solar tracking systems has the potential to significantly enhance the performance and efficiency of solar energy generation. This study provides empirical evidence that organizations in the renewable energy sector are generally aware of the benefits of IoT technologies, such as improved monitoring, remote control, and data analytics. However, the adoption of IoT-based solar tracking systems is still relatively low, with only a small percentage of respondents reporting the use of these technologies in their organizations.

The findings of this study suggest that the key factors influencing the adoption of IoT-based solar tracking systems include relative advantage, compatibility, complexity, trialability, and observability. Organizations that perceive IoT technologies as providing significant benefits in terms of improved performance, reduced costs, and enhanced decision-making are more likely to adopt these technologies. Similarly, organizations that find it easy to integrate IoT technologies with their existing solar tracking systems and infrastructure are more likely to adopt these technologies.

The study also identified several challenges that organizations face in integrating IoT with solar tracking systems, including technical challenges related to data security, interoperability, and scalability, organizational challenges related to lack of technical expertise, resistance to change, and limited financial resources, and regulatory challenges related to uncertainty around data privacy and security regulations and lack of clear guidelines for the deployment of IoT technologies in the renewable energy sector.

To overcome these challenges, organizations need to invest in developing the necessary technical expertise, establishing clear data governance policies, and collaborating with industry partners and

policymakers to address regulatory barriers. By doing so, organizations can accelerate the adoption of IoT-based solar tracking systems and realize the full potential of these technologies in improving the performance and efficiency of solar energy generation.

The findings of this study have important implications for both researchers and practitioners in the renewable energy sector. For researchers, the study provides a foundation for future research on the integration of IoT with solar tracking systems, including the development of new theoretical frameworks and empirical models to explain the adoption and impact of these technologies. For practitioners, the study offers insights into the key factors that influence the adoption of IoT-based solar tracking systems and the challenges that organizations face in implementing these technologies. By understanding these factors and challenges, practitioners can develop more effective strategies for deploying IoT technologies in the renewable energy sector.

5.3. Recommendations:

-Invest in developing technical expertise: Organizations need to invest in training their employees on the use of IoT technologies and building in-house technical capabilities to support the integration of these technologies with solar tracking systems. This could involve partnering with educational institutions or technology providers to develop customized training programs.

-Collaborate with industry partners and policymakers: Organizations need to collaborate with industry partners, such as technology providers and system integrators, to address technical challenges and develop interoperable solutions. They also need to engage with policymakers to address regulatory barriers and develop clear guidelines for the deployment of IoT technologies in the renewable energy sector. This could involve participating in industry associations, lobbying groups, or policy forums to advocate for the adoption of IoT technologies in the renewable energy sector.

-Develop business models that capture the value of IoT technologies: Organizations need to develop innovative business models that capture the value of IoT technologies in improving the performance and efficiency of solar energy generation. This could involve offering performance-based contracts, where organizations are compensated based on the actual energy generated by the solar tracking systems, or developing new revenue streams based on the data generated by these systems.

-Engage with end-users and communities: Organizations need to engage with end-users and communities to raise awareness about the benefits of IoT-based solar tracking systems and address any concerns or misconceptions about these technologies. This could involve organizing public awareness campaigns, educational workshops, or community engagement events to showcase the benefits of these technologies and their potential impact on the environment and local communities.

5.4. Suggestions for further study

The study has several limitations that suggest opportunities for future research. First, the cross-sectional nature of the study limits the ability to infer causal relationships between the variables of interest. Future studies could employ longitudinal designs to track the adoption and performance of IoT-based solar tracking systems over time. Second, the study focused on organizations in a specific geographic region. Future studies could expand the scope to include organizations from different countries or regions to explore the influence of cultural and regulatory factors on the adoption of IoT technologies. Third, the study relied primarily on survey data, which may not capture the full complexity of the phenomenon. Future studies could employ mixed-methods approaches that combine quantitative and qualitative data to provide a more comprehensive understanding of the integration of IoT with solar tracking systems.

References

Arduino.cc. (2010). *Arduino UNO*.

Arka360. (2023).

Arkresources. (2023).

Boulder, U. o. (2023).

Circuitdigest. (August 1, 2015).

Expressif. (September 6, 2016).

Gnetek. (2023).

History, S. c. (1983).

Laborator, N. P. (1983).

McFee. (2020).

MDPI. (March,29 2024).

paste.txt. (n.d.).

Preproom. (1994).

Sciencedirect. (2023).

Verma, S. (January 17, 2022).

APPENDICES:

Appendice A:code of the Sunlight tracking system

```
#include <Servo.h>

// Define LDR pins
#define LDR_TOP A0 // Top LDR
#define LDR_BOTTOM A1 // Bottom LDR
#define LDR_LEFT A2 // Left LDR
#define LDR_RIGHT A3 // Right LDR

// Define servo pins
#define SERVO_HORIZ 9 // Horizontal servo
#define SERVO_VERT 8 // Vertical servo

// Create servo objects
Servo servoHoriz, servoVert;

// Variables to store the servo positions
int posHoriz = 90; // Start at middle position
int posVert = 90; // Start at middle position

// Sensitivity threshold
const int threshold = 10;

void setup() {
    // Attach servos to their respective pins
    servoHoriz.attach(SERVO_HORIZ);
    servoVert.attach(SERVO_VERT);

    // Set initial servo positions
    servoHoriz.write(posHoriz);
    servoVert.write(posVert);
}
```

```

void loop() {
  // Read LDR values
  int ldrTop = analogRead(LDR_TOP);
  int ldrBottom = analogRead(LDR_BOTTOM);
  int ldrLeft = analogRead(LDR_LEFT);
  int ldrRight = analogRead(LDR_RIGHT);

  // Calculate differences for vertical tracking
  int verticalDiff = ldrTop - ldrBottom;

  // Adjust vertical servo position
  if (abs(verticalDiff) > threshold) { // Use defined threshold
    if (verticalDiff > 0) {
      posVert += 1; // Move up
    } else {
      posVert -= 1; // Move down
    }
  }
  // Keep within bounds
  posVert = constrain(posVert, 0, 180);
  servoVert.write(posVert);
}

```

Appendice B: Code of the IoT controller

```

#include <WiFi.h>
#include <HTTPClient.h>
#include <ArduinoJson.h>
#include <Wire.h>
#include <Adafruit_GFX.h>
#include <Adafruit_SSD1306.h>
#include <LiquidCrystal_I2C.h>
#include <time.h>

```

```

// WiFi Credentials
const char* ssid = "MASTERS";
const char* password = "ulk@1234";

// OpenWeatherMap API Credentials
String URL = "http://api.openweathermap.org/data/2.5/weather?";
String ApiKey = "e3330ba8330942881852014af25f07f9";

// Location Coordinates
String lat = "-1.9274167000000004";
String lon = "30.054888899999998";

// Timezone and DST offset in seconds
#define TZ_OFFSET 3600 * 2 // Adjust based on your timezone
#define DST_OFFSET 0 // Adjust based on your DST

// OLED display width and height
#define SCREEN_WIDTH 128
#define SCREEN_HEIGHT 64
// SPI OLED pins
#define OLED_SDA 23
#define OLED_CLK 18
#define OLED_DC 16
#define OLED_CS 5
#define OLED_RESET 17

// Battery voltage pin
#define BATTERY_VOLTAGE_PIN 36 // Adjust this pin based on your setup

// LCD Pins
#define LCD_SDA 21
#define LCD_SCL 22

// Declaration for an SSD1306 display connected to SPI

```

```
Adafruit_SSD1306 display(SCREEN_WIDTH, SCREEN_HEIGHT, &SPI, OLED_DC, OLED_RESET,
OLED_CS);

// LCD Initialization
LiquidCrystal_I2C lcd(0x27, 16, 2); // Adjust the address based on your LCD

// Define pins for LEDs
const int LED_IMPORTANT_PIN = 15; // LED for important components
const int LED_NON_ESSENTIAL_PIN = 2; // LED for non-essential components
```